

# KX-E4500

## Operator's Instruction Manual



\*Shown with optional CRT support arm.

**Panasonic**

## FOR USERS IN UNITED STATES ONLY

This equipment has been tested and found to comply with the limits for a Class B digital device, pursuant to Part 15 of the FCC Rules. These limits are designed to provide reasonable protection against harmful interference in a residential installation. This equipment generates, uses and can radiate radio frequency energy and, if not installed and used in accordance with the instructions, may cause harmful interference to radio communications. However, there is no guarantee that interference will not occur in a particular installation. If this equipment does cause harmful interference to radio or television reception, which can be determined by turning the equipment off and on, the user is encouraged to try to correct the interference by one or more of the following measures:

- Reorient or relocate the receiving antenna.
- Increase the separation between the equipment and receiver.
- Connect the equipment into an outlet on a circuit different from that to which the receiver is connected.
- Consult the dealer or an experienced radio/TV technician for help.

The user may find the booklet "Something About Interference" available from FCC local regional offices helpful.

**FCC Warning:** To assure continued FCC emission limit compliance, the user must use only the recommended shielded interface cable when connecting to computer or peripheral. Also, any unauthorized changes or modifications to this equipment would void the users authority to operate this device.

## WARNING

- When you operate this equipment, the power outlet should be near the equipment and be easily accessible.
- Power source voltage of this unit is listed on the nameplate. Do not fail to plug the typewriter into an outlet with the proper voltage.
- To prevent fire or shock hazard, do not expose this product to rain or any type of moisture.

The serial number of the unit may be found on the inside label. For your convenience, note this number in the space provided below, and retain this book along with your proof of purchase, to serve as a permanent record in the event of a theft, or for future reference.

MODEL NO. \_\_\_\_\_ NAME OF DEALER \_\_\_\_\_

SERIAL NO. \_\_\_\_\_ DATE OF PURCHASE \_\_\_\_\_

# Preface

---

Congratulations! You are about to enter the exciting world of electronic typing with one of the most advanced electronic typewriters available today.

Your Panasonic typewriter has been designed to help you prepare your typing projects as simply and efficiently as possible.

Many of your tedious typing tasks may now be performed quickly and automatically. By reading through the manual, you will learn how to operate all of the functions which will help you on a day-to-day basis.

It is important that you read this manual and do the exercises. It has been designed to teach you every function your Panasonic typewriter has to offer. Once you have completed this manual, you will find it easier to do many of your daily typing projects.

Take the time to learn everything you can about your new typewriter. We are convinced you will find typing much more interesting and your finished projects cleaner, more professional looking, and much easier to do.

We hope you enjoy using your Panasonic typewriter and are confident you will have many years of reliability ahead of you.

-

# TABLE OF CONTENTS

## Preface

<b>1. LEARNING THE BASICS</b> .....	1
• Part Functions .....	2
Keyboard Adjustment Lever .....	2
Power On/Off Switch .....	2
Paper Release Lever .....	2
Paper Bail Release Lever .....	3
Copy Control Lever .....	3
Cover Interlock Switch .....	3
CRT Brightness Control .....	3
<b>2. KEYBOARD LAYOUT</b> .....	4
• Character Keys .....	4
• Selector Switches .....	5
Line Spacing Selector .....	5
Mode Selector .....	5
Pitch Selector .....	6
Impact Control Selector .....	6
KB I/KB II Selector .....	7
Accessing KB II .....	7
• Function Keys .....	8
<b>3. DEFAULT SETTINGS</b> .....	10
• Accessing the Default Settings Menu .....	10
• Default Settings Menu Overview .....	11
Printed Lines Per Page .....	11
Form Feed .....	11
Lines Per Inch .....	11
Dec Tab Character .....	12
Low Impact .....	12
Cursor Shape .....	12
Blinking Cursor .....	12
Background Color .....	12
Auto Paper Insertion .....	12
KB Symbols Displayed .....	13
Display Characters As .....	13
• Changing the Default Settings .....	13
Changing the Printed Lines Per Page or the Forms Feed setting .....	13
<b>4. DISPLAY OVERVIEW</b> .....	14
• Status Line .....	14
Typewriter Mode .....	14
Memory Mode .....	15
• Ruler Line .....	15
• Display Messages .....	15
• Display Symbols .....	16
• Changing the Background Color .....	17
• Changing the Cursor Shape .....	18
• Turning the Cursor Blinking On and Off .....	19

• Changing the KBII Symbols Displayed .....	20
• Changing all Characters to Display as Bold .....	21
• Embed .....	22
Embedding Non-Printable Symbols .....	22
Displaying Non-Printable Symbols .....	22
• Controlled Printer Movement .....	23
Typewriter Mode .....	23
Memory Mode .....	23
Activating Controlled Printer Movement .....	23
Deactivating Controlled Printer Movement .....	23

## 5. USING THE TYPEWRITER .....

• Help .....	24
Accessing Help in the Typewriter Mode .....	24
Accessing Help in the Memory Mode .....	24
Exiting the Help Menu .....	24
• Automatic Paper Insertion .....	25
Changing the Paper Insertion Position .....	25
Restting the Default Paper Insertion Position .....	25
• Automatic Paper Eject .....	26
Automatically Ejecting the Paper .....	26
• Index/Reverse Index .....	26
• Micro Index .....	26
Micro Indexing .....	26
• Margins and Tabs .....	27
Setting Margins and Tabs .....	27
Clearing a Tab Stop .....	28
Clearing All Tabs and Retaining Margins .....	28
Clearing All Margins and Tabs .....	28
Adjustable Hot Zone .....	29
Setting the Hot Zone .....	29
• Store Ruler .....	30
Storing Margins and Tabs .....	30
• Recall Ruler .....	32
Recalling Margins and Tabs .....	32
• Edit Ruler .....	33
Editing Margins and Tabs .....	34
• Typing on Display in the Typewriter Mode .....	35
• Corrections .....	36
Within the Correction Memory .....	37
Correcting Errors on the Same Line .....	37
Correcting Errors on Previous Lines .....	37
Out of the Correction Memory .....	38
Using the No Print Method .....	38
Making Manual Corrections .....	39
Correcting Errors on Display in the Typewriter Mode .....	41

<b>6. AUTOMATED TYPING FEATURES</b> .....	42
• Caps Lock .....	42
• Bold Print .....	42
• Underscore .....	43
Continuous Underscore .....	43
Word by Word Underscore .....	44
Double Underscore .....	44
• Centering .....	45
Between Margins .....	45
Over a Point .....	45
Between Tab Stops .....	46
Aligned at the Right Margin .....	46
• Indent .....	47
Left Indent .....	47
Indenting the Left Side of the Text .....	47
Block Indent .....	48
Indenting Both Sides of the Text .....	48
• Decimal Tabulation .....	49
Using Decimal Tabulation .....	50
• Temporary Hyphen .....	51
Inserting a Temporary Hyphen .....	51
• Permanent Space .....	52
Entering a Permanent Space .....	52
• Micro Space .....	52
Entering a Micro Space .....	52
• Permanent Backspace .....	53
Entering a Permanent Backspace .....	53
<b>7. MEMORY</b> .....	55
• Typing in Memory .....	56
• Correcting Errors in Memory .....	57
• Phrase Memory .....	58
Storing a Phrase .....	59
Editing a Phrase .....	61
Printing a Phrase .....	61
Clearing a Phrase .....	62
Listing Phrases .....	62
Writing Phrases into Text Memory .....	64
Reading Phrases from Text Memory into Phrase Locations .....	65
Phrase Link .....	67
Linking Phrases .....	67
Addressing Envelopes with Phrases .....	68
• Text Memory .....	69
• Main Menu Overview .....	69
• Create .....	70
Creating a Text .....	70

• Edit	72
Recalling a Text for Modification	72
Recalling a Ruler in Text Memory	73
Editing a Ruler in Text Memory	74
Changing Line Spacing within a Text	75
Hyphenatin Scan	76
Scanning Text for Hyphenation Requests	76
Jumping to a Page	77
Search	78
Activating a Search	79
Global Search and Replace	80
Activating a Global Search and Replace	80
Selective Search and Replace	81
Activating a Selective Search and Replace	81
Block Move, Copy, Delete, and Print	82
Marking a Block of Text	82
Deleting a Block of Text	83
Moving a Block of Text	83
Copying a Block of Text	84
Printing a Block of Text	84
Removing Marks from a Block of Text	85
• Print	86
Page End	86
Activating Page End	87
Deactivating Page End	87
Printing with a Page End Command Activated	88
Typewriter Mode	88
Text Memory Mode	88
Printing from within a Text or Phrase	89
Halt Print	89
Halting a Print Command	89
Printing from the Main Menu (Background Print)	90
Printing a Single Text in Background Print	91
Printing Multiple Copies of the Same Text	92
Headers/Footers	93
Storing a Header/Footer	93
Printing Text with a Header/Footer	93
Page Numbering	94
Printing a Text with Page Numbers	94
Printing Multiple Texts in Background Print	95
Deleting from the Print Queue	96
Text Linking	97
Linking Texts	97
<b>8. APPLICATIONS</b>	<b>101</b>
• Centering Application for Columns	102
• Automatic Column Layout	103
Setting a Column Layout	103
• Insert Codes	105
Creating a Text with Insert Codes	105
Printing a Text with Insert Codes	107

• Inserting a Manual Page Break in Text Memory . . . . .	108
• Inserting a Phrase into Text . . . . .	109
• Append . . . . .	110
Appending an Entire Text . . . . .	110
Appending a Block of Text . . . . .	111
• Line Framing . . . . .	112
Line Framing on a Printed Page . . . . .	112
Drawing Vertical Lines . . . . .	114
Drawing Horizontal Lines . . . . .	115
Line Framing while Creating a Text in Memory . . . . .	117
Deleting a Line Frame Command within a Text . . . . .	118
• Dual Column Typing . . . . .	119
Setting a Dual Column Format . . . . .	119
Typing a Dual Column Text in Typewriter Mode . . . . .	121
• Dual Column Text in Memory . . . . .	122
Typing a Dual Column Text in Memory . . . . .	123
Exiting a Dual Column Format in Memory . . . . .	126
Printing a Dual Column Text . . . . .	126
• Mail Merge . . . . .	128
Form Letter . . . . .	128
Creating a Form Letter . . . . .	129
Mail List . . . . .	130
Creating a Mail List . . . . .	132
Merge Overview . . . . .	133
Printing on Individual Sheets of Paper . . . . .	133
Printing on Continuous Paper . . . . .	133
Merging a Form Letter and Mail List . . . . .	134
Qualifying Line . . . . .	136
Entering a Qualifying Line . . . . .	136
Wildcards . . . . .	137
Selectively Printing from a Qualified Mail List . . . . .	138
Counting Letters to be Merged . . . . .	139
Using the Mail List to Print Envelopes . . . . .	139
Using the Mail List to Print Labels . . . . .	142
Merging a Mail List Directly from Disk . . . . .	143
• Forms Layout . . . . .	144
Setting up the Form . . . . .	145
Stop Positions . . . . .	146
Storing Stop Positions . . . . .	147
Form Fill-In . . . . .	149
Filling-In a Form . . . . .	150
Correcting Errors on a Form . . . . .	151
Correcting Errors at a Current Stop Position . . . . .	151
Correcting Errors at a Previous Stop Position . . . . .	151
Adding Stop Positions . . . . .	152
Inserting a Stop Position to the Left of the Current Stop . . . . .	152
Deleting Stop Positions . . . . .	152
Deleting an Automatic Phrase Insertion Stop Position . . . . .	153
Editing Prompts . . . . .	153



<b>9. SPELLCORRECT®</b> .....	154
• SpellCorrect® Menu Overview .....	155
Typewriter Mode .....	155
Memory Mode .....	155
• Turning SpellCorrect® On .....	156
• Turning SpellCorrect® Off .....	156
• Quit .....	157
Quitting SpellCorrect® .....	157
• Making Manual Corrections .....	158
• Alternatives .....	159
• Displaying Alternate Spelling Suggestions .....	159
• Correcting a Double Word .....	160
• Skip .....	161
Skipping a Flashing Word .....	161
• Insert .....	162
Inserting a Word into the Glossary with SpellCorrect® On .....	163
Inserting a Word into the Glossary with SpellCorrect® Off .....	164
• Delete .....	165
Deleting a Word from the Glossary .....	165
• Scan .....	166
Scanning a Text or Phrase Memory .....	166
• Glossary .....	168
Inputing a Text Memory into the User Glossary .....	168
Outputing a Glossary to Text Memory .....	170
• List .....	172
Listing the Glossary .....	172
Printing the Glossary .....	173
• Clear .....	174
Clearing a Glossary .....	174
 <b>10. TEXT MANAGEMENT</b> .....	 175
• Advancing from One Phrase Location to Another .....	176
• Advancing from One Text Location to Another .....	177
• List .....	178
Displaying a List of Text Names .....	178
Printng a List of Text Names .....	179
• More .....	180
Renaming a Text from the Main Menu .....	180
Renaming a Text while in Memory .....	181
Deleting a Text while in Memory .....	182
Deleting a Single Text from Memory .....	182
Deleting Multiple Texts from Memory .....	184
• Clearing All Text Memory .....	186
• Clearing All Phrase Memory .....	187
• Clearing All Memory .....	188
• Resetting the Printer .....	189
• Displaying the Amount of Memory Available .....	189

	<b>11. DISK</b> .....	190
	• Disk Menu Overview .....	191
	• Inserting a Micro-Floppy Disk .....	192
	• Ejecting a Micro-Floppy Disk .....	192
	• Protecting a Micro-Floppy Disk from Erasure .....	193
	• Formatting a Disk .....	194
	• Write .....	196
	Writing a Single Text to Disk .....	196
	Writing Multiple Texts to Disk .....	198
	• Read .....	200
	Reading a Single Text into Memory .....	201
	Reading Multiple Texts into Memory .....	202
	• List .....	204
	Displaying a Disk Directory .....	204
	Printing a Disk Directory .....	206
	• More .....	207
	Renaming a Text on Disk .....	207
	Deleting a Single Text from Disk .....	209
	Deleting a Multiple Texts from Disk .....	211
	Printing a Text from Disk .....	214
	Loading Texts from Other Panasonic Typewriters .....	216
	Loading an ASCII file .....	218
<b>1</b>		
<b>2</b>		
<b>3</b>		
<b>4</b>		
<b>5</b>		
<b>6</b>	<b>12-1. SCREEN MESSAGES</b> .....	220
<b>7</b>	<b>12-2. CODE OPERATIONS CHART</b> .....	222
<b>8</b>	<b>12-3. CAUTIONS</b> .....	225
	• Batteries .....	225
	• Cleaning .....	225
	• Handling Disks .....	225
	• Cables .....	225
<b>9</b>	<b>12-4. CHANGING SUPPLIES</b> .....	226
	• Changing the Ribbon Cartridge .....	226
	• Changing the Correction Tape .....	227
	• Changing the Daisywheel .....	228
	• Changing the Batteries .....	229
<b>10</b>		
<b>11</b>	<b>12-5. PLATEN REMOVAL AND INSTALLATION</b> .....	230
	• Removing the Platen .....	230
	• Installing the Platen .....	231
<b>12</b>	<b>12-6. SHIPPING INFORMATION</b> .....	232
	• Disconnecting the Display Unit .....	232
	<b>12-7. TROUBLESHOOTING</b> .....	233
	<b>12-8. SPECIFICATIONS</b> .....	234
	<b>12-9. OPTIONS</b> .....	235
	<b>12-10. INDEX</b> .....	236

# 1. LEARNING THE BASICS

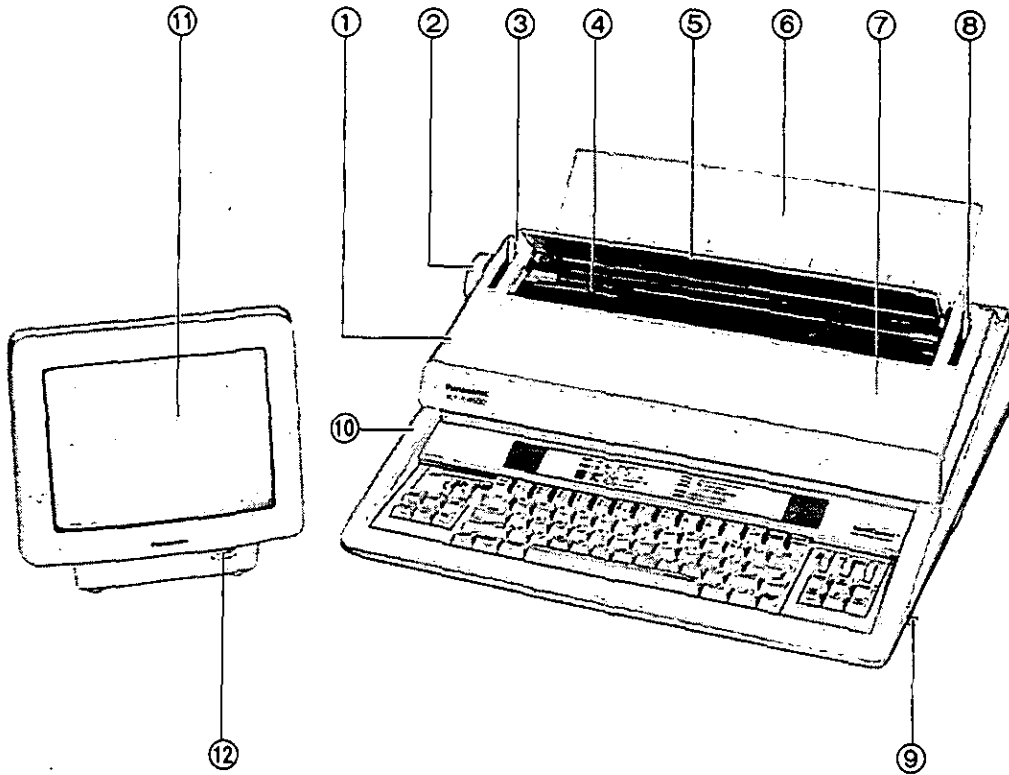

1

① **Power ON/OFF Switch**

② **Platen Knob**  
Manually feeds paper

③ **Paper Bail Release Lever**  
Moves the paper bail away from the platen

④ **Acoustic Filter**  
Suppresses printing sounds

⑤ **Anti-Glare Shield**  
Minimizes glare

⑥ **Paper Support**

⑦ **Top Cover**

⑧ **Paper Release Lever**  
Releases paper

⑨ **Keyboard Adjustment Lever**  
Adjusts the keyboard layout into two levels

⑩ **Floppy Disk Drive**

⑪ **CRT (Screen)**

⑫ **CRT Brightness Control**

# Part Functions

1

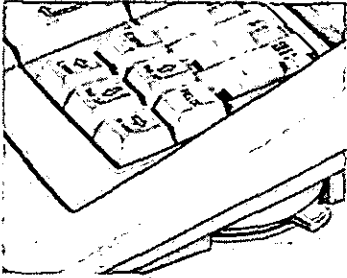

## Keyboard Adjustment Lever

This lever enables you to adjust the keyboard to your own comfort level. You have a choice of two levels, angled or flat.

### To Angle the Keyboard:

- Move the Keyboard Adjustment Lever toward the front of the typewriter

### To Lay the Keyboard Flat:

- Move the Keyboard Adjustment Lever toward the back of the typewriter

## Power ON/OFF Switch

The power ON/OFF switch is located toward the back left-hand side of the typewriter.

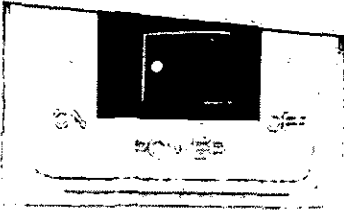

When you turn the machine on, the daisywheel will spin to position itself accurately, the printer will position itself to the left margin and the typewriter will resume the margins and tabs that were set when it was turned off.

## Paper Release Lever

Pulling forward on the Paper Release Lever releases the pan which holds the paper tight against the platen and enables the operator to adjust the paper freely.

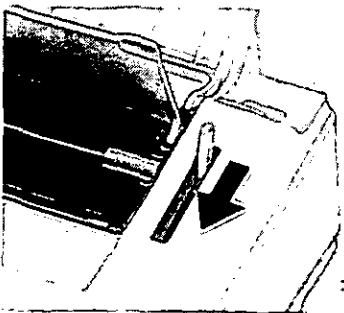

---

## Paper Bail Release Lever

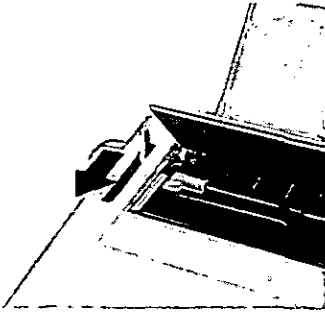

Pulling forward on the Paper Bail Release Lever moves the paper bail away from the platen. Additional forward movement of this lever activates the automatic paper insert function.

1

## Copy Control Lever

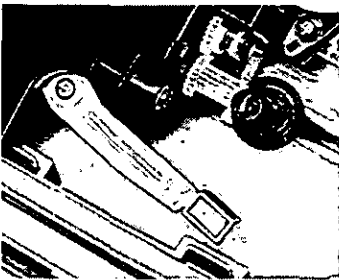

The Copy Control Lever, is located on the inner right side of the typewriter, just below the ribbon cartridge. This lever adjusts the space between the platen and the silver pan just below it. This enables the operator to insert thick forms or envelopes.

Cover Interlock Switch

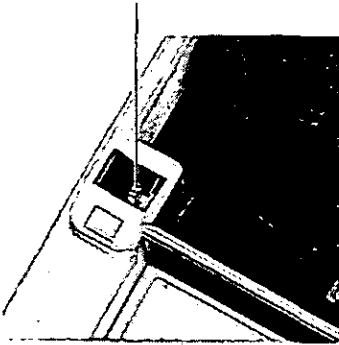

## Cover Interlock Switch

The top cover has a safety interlock switch which deactivates the printer and keyboard whenever the top cover is opened.

## CRT Brightness Control

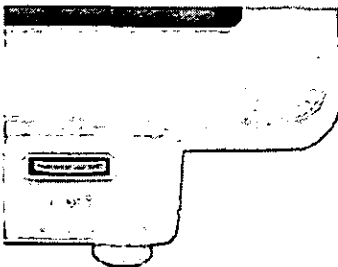

The Brightness Control knob, which is located on the lower right-hand side of the CRT, enables you to choose the level of "brightness" or "darkness" that makes it most comfortable for you to view your screen.

# 2. KEYBOARD LAYOUT

In order to simplify the explanation of the typewriter and its capabilities, the keyboard has been divided into three (3) separate sections: **Character Keys**, **Selector Switches**, and **Function Keys**.

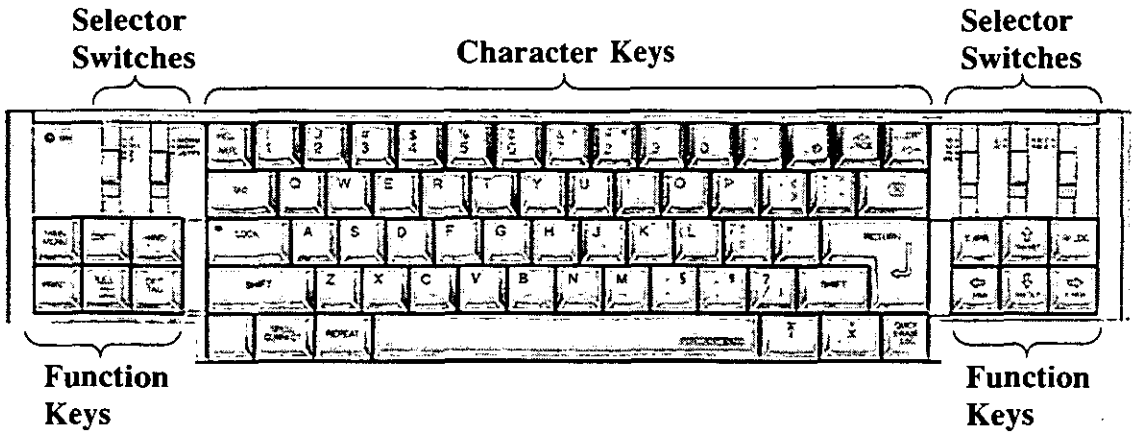

## Character Keys

The KX-E4500 Character Keys are clearly labeled for ease of use. All coded functions are labeled in blue and correspond with the CODE key, which is also labeled in blue. All operations which need to be performed with the SHIFT key are framed in a box. Keys with one or two characters to the right of the traditional characters offer special symbols. These symbols are accessed in KB II. For more information on KB II refer to page 7.

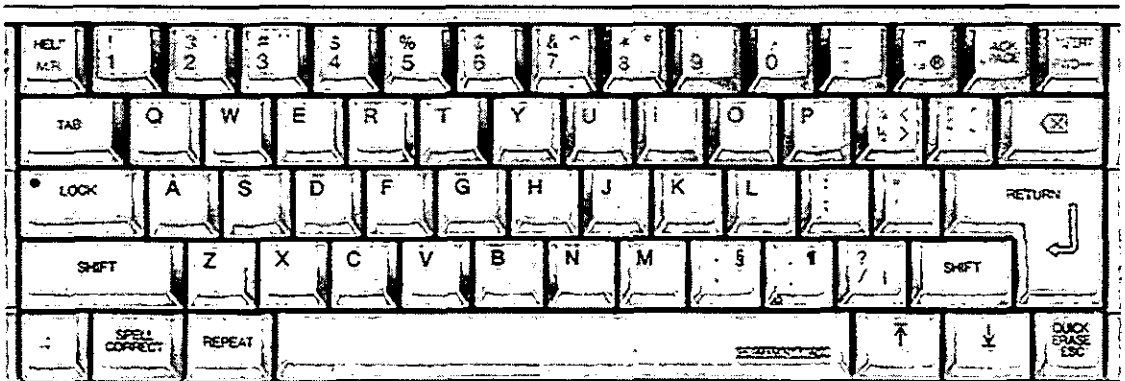

# Selector Switches

A total of five selector switches are located on the KX-E4500.

## Line Spacing Selector

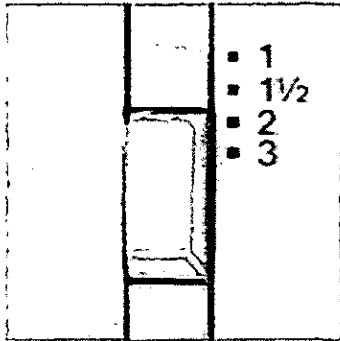

The Line Spacing Selector is located on the top left of the keyboard. It is marked 1, 1½, 2, and 3 and is used to control the number of lines between each RETURN.

You may also select from three different lines per vertical inch settings which are accessed through the default menu discussed on page 11. These choices and their uses are listed below:

- 5.25 — Legal Applications (court reporting)
- 6 — Normal Correspondence
- 8 — Used in conjunction with 15 pitch

## Mode Selector

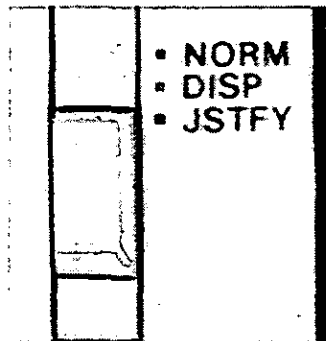

The Mode selector is located to the immediate right of the line spacing selector. It controls your typing output by offering you three modes of operation: **NORM**, **DISP**, **JSTFY**.

- NORM** Deactivates your display screen allowing you to type directly on the paper. When you come to the end of a line, a manual return is required.
- DISP** Accesses the display screen allowing you to view one line of text before it is printed on the paper. **DISP** will also trigger an automatic return at the end of each line.
- JSTFY** Works the same as the **DISP** mode. However, in the **JSTFY** mode, your text will print with an even right margin, giving your work a clean, professional look.

---

## Pitch Selector

On the right side of the keyboard is the Pitch Selector which is labeled 10, 12, 15, and PS. The Pitch Selector indicates the number of characters printed per inch as outlined below:

10 PICA	10 Characters per inch
12 ELITE	12 Characters per inch
15 MIKRON	15 Characters per inch
PS PROPORTIONAL	Variable Spacing

For the best results, your Pitch Selector switch should correspond with the pitch of the daisywheel in your typewriter.

## Impact Control Selector

The Impact Control Selector, which is located to the right of the Pitch Selector, dictates to the printer how hard the characters on the daisywheel will strike the page. You have a choice of two settings: L (light) and H (heavy).

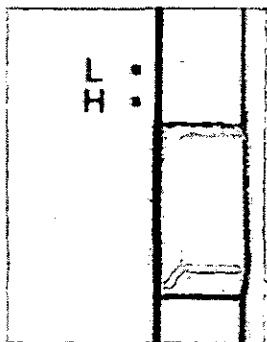
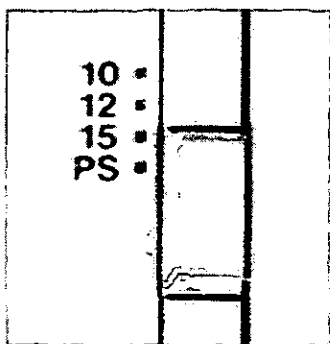



## KB I/KB II Selector

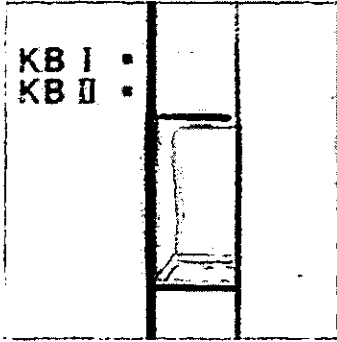

The KB I/KB II selector switch is located to the far right of the keyboard. KB I allows printing of the alpha/numeric symbols normally associated with a traditional keyboard. On keys which contain three or more characters, KB II enables you to access the symbols located on the right side of the traditional characters.

### Accessing KB II

- Move the selector switch to KB II.

The symbols to the right side of the traditional characters are now available for use.

If the symbol is located on the upper right side of the traditional character,

- Press **SHIFT + the Desired Key**

If the symbol is located to the lower right side of the traditional character,

- Press the **Desired Key** (no shift is required)

Panasonic offers two types of daisywheels:

- D2—For American Symbols
- D1—For International Symbols

This is a sample of the special keyboard II symbols on the 200 series (D2) Daisywheels which are commonly used for applications in legal, scientific, publishing, and other specialized typing.

2 . . . ® ´ < > § ¶ |

This is a sample of the special keyboard II symbols on our 100 series (D1) Daisywheels which allow typing in other languages.

£ ¨ ^ ç é Ñ ñ ´ ` ¡ ¿ |

A D1 daisywheel is also used when the selection "NY" for NY Spanish keyboard is selected under the Default Settings menu. Under this selection, the KX-E4500 keyboard becomes ideal for operators familiar with a true Spanish keyboard. Spanish symbols are accessed under the KB I selection and the remaining international symbols are accessed under KB II.

# Function Keys

2

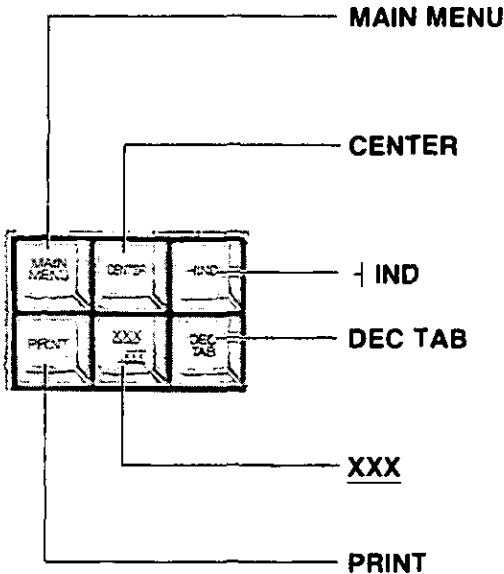

Displays a list of memory options. The internal memory, disk, and print functions are all accessed through the Main Menu key.

Allows you to center four ways: between margins, over a point, between tabs, or right margin flush.

Sets a temporary left margin.

Advances the printer to the next tab position and aligns the decimal point or comma on the tab position.

Sets and releases the automatic underscore command.

Initiates the printer while in memory. It advances to "fill-in" positions in Forms Layout. The No Print mode is activated when the **PRINT** key is used in conjunction with the **CODE** key.

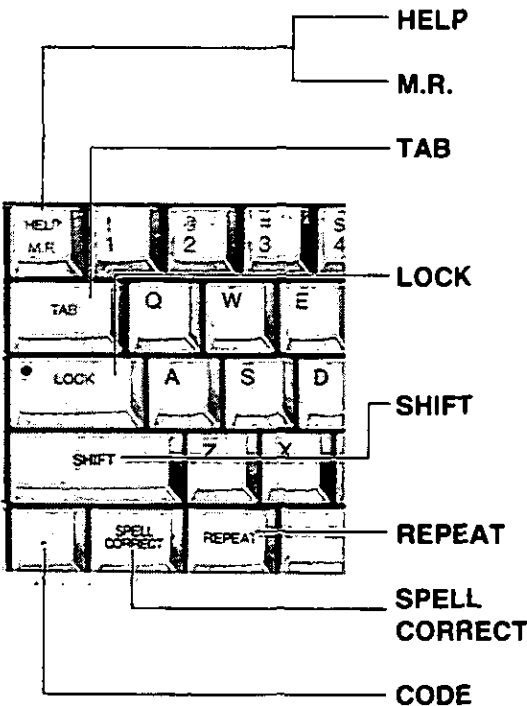

Displays **HELP** menu for Coded functions.

Margin release for left and right margins.

Advances the printer to the next tab position, and aligns all characters to the right of the tab setting.

Allows typing of capital letters without holding down the **SHIFT** key. Caps lock is activated when used with the **CODE** key.

Allows typing of capital letters. It also accesses the automated features which are framed in a box on the keytops.

Makes every key a repetitive key.

Turns the SpellCorrect® feature on and off.

Is used in conjunction with other keys (most of which are clearly labeled in blue) to perform automated functions.

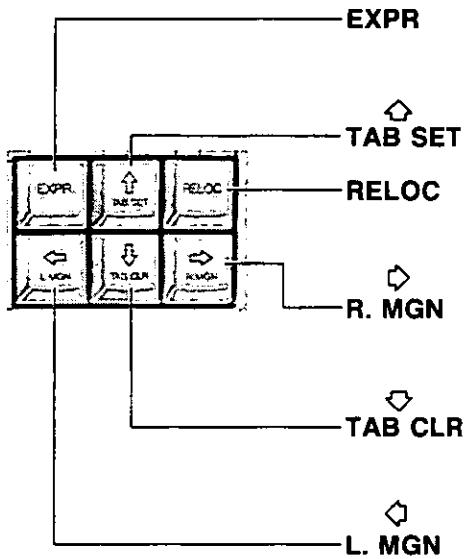

**EXPR**  
Moves the printhead to the beginning of the line without line spacing.

**TAB SET**  
Moves the cursor up one line in memory. Sets TAB stop positions (maximum 28).

**RELOC**  
Moves the printhead to the last character on the paper.

**R. MGN**  
Moves the cursor to the right in memory. Sets the right margin. Used with the **CODE** key, it sets the hot zone.

**TAB CLR**  
Moves the cursor down one line in memory. Clears TAB stops. When used with the **CODE** key, it clears all tabs, or all margins and tabs.

**L. MGN**  
Moves the cursor to the left in memory. Sets the left margin.

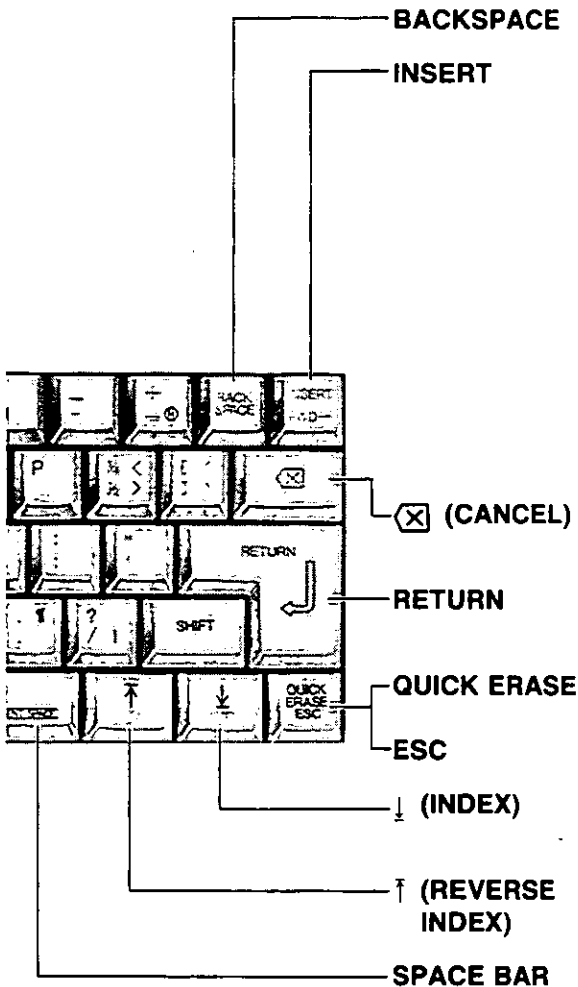

**BACKSPACE**  
Moves the printer one space to the left.

**INSERT**  
The **INSERT/FWD→** key is used primarily when editing text on the display.

In the Typewriter Mode, it is the Forward (**FWD→**) key and advances the cursor one character to the right on the display.

In the Memory Mode, it acts as a toggle between the insert and overwrite methods of typing. Insert, which is the default setting, enables you to add words between existing text. Overwrite replaces existing text with newly typed characters.

**X (CANCEL)**  
Deletes the character to the left of the printhead.

**RETURN**  
Advances one line down, and brings the printhead back to the left margin.

**QUICK ERASE**  
Deletes the entire word to the left of the printhead. Cancels current pop up or prompt.

**ESC**  
Advances a 1/2 line toward the bottom of the page.

**INDEX**  
Moves a 1/2 line toward the top of the page.

**REVERSE INDEX**  
Advances the printhead to the right. When used with the **CODE** key, it moves the printhead 1/6th of an inch if your pitch is set on 10.

# 3. DEFAULT SETTINGS

The KX-E4500 is shipped with pre-set characteristics such as the background color of your display or the number of printed lines per page. The default settings menu enables you to change the pre-programmed characteristic of the typewriter to meet your individual requirements. When you make a change to the default settings menu, it will remain until you access the default settings again.

## 3 Accessing the Default Settings Menu

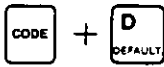

- Press **CODE + D** (for Default)

Your screen will prompt:

DEFAULT SETTINGS			
<b>Printed Lines Per Page</b>		[54]	lines
Form Feed		[66]	lines
Lines Per Inch	5.25	6	8
Dec Tab Character	<b>Period</b>	Comma	
Low Impact	Yes	<b>No</b>	
Cursor Shape	<b>Block</b>	Underline	
Blinking Cursor	No	<b>Blink</b>	
Background Color	Black	<b>White</b>	
Auto Paper Insertion	<b>Default</b>	No	
KB Symbol Displayed	D1	<b>D2</b>	NY
Display Characters As	<b>Normal</b>	Bold	

RETURN to Enter, RELOC to Enter All or ESC

# Default Settings Menu Overview

## Printed Lines Per Page

Printed lines per page defines the number of lines to print on each page.

Example:

You are using a standard sheet of paper (8.5"×11") and the auto paper insertion is set at 7 lines for a one inch margin at the top of the paper. In addition, you may also require a one inch bottom margin. If you subtract 12 lines from the total available lines (66) this would equal 54 printed lines per page.

## Form Feed

The paper length is calculated in lines and relates to the lines per inch setting. To arrive at this calculation, simply multiply the length of the paper in inches by the number of lines to the inch.

Example: 6 vertical lines per inch

11" letter size paper=66 lines

14" legal size paper=84 lines

## Lines Per Inch

The number of lines per inch represents the spacing between two printed lines on a page. When using a traditional format, 6 is the standard setting. For legal applications 5.25 spacing is usually appropriate. When using a 15 pitch printwheel, the line spacing should be set on 8 to minimize excess white space between the lines.

---

## Dec Tab Character

You may choose to align numbers at the decimal point (period) or comma.

## Low Impact

The KX-E4500 offers low impact ribbons to reduce noise levels. If you are using this ribbon type, select “Yes.”

**NOTE:** If you select “Yes” and you are not using a low impact ribbon, Panasonic will not assume responsibility for inconsistent print quality. If you experience inconsistent print quality, change this setting to correspond with the correct ribbon type.

## Cursor Shape

The cursor indicates the current position on the Display Screen. You can select Block or Underline for the cursor shape.

## Blinking Cursor

In addition to the shape of the cursor, the cursor can be changed to a blinking cursor or non-blinking cursor.

## Background Color

The default background color is a white background with black characters. The background color can be reversed at any time by selecting Background Color and selecting black background with white characters.

## Auto Paper Insertion

The typewriter is pre-programmed to insert your paper seven (7) lines from the top of the page. You can change your insertion position in Typewriter Mode by using **CODE + A**. When the insertion position is changed, the word “No” will be highlighted on the Auto Paper Insertion line of the Default settings menu. The Auto Paper Insertion selection on the Default settings menu is provided so that you can re-set your insertion position to the original default setting of a 1” top margin quickly and easily.

- To re-set the default insertion position, simply select Default on the Auto Paper Insertion line and press **RELOC**.

---

## KB (Keyboard) Symbols Displayed

The default KBII symbols displayed are American symbols (D2) to agree with the D2 daisywheel shipped with your machine. The KBII symbols should only be changed when a D1 daisywheel for International symbols is used in the typewriter. This selection enables you to display the correct symbols to correspond with your daisywheel.

## Display Characters As

The line "Display Characters As" enables you to display all characters in a bold or darker display and characters to be printed in bold face will be displayed in a normal or lighter display.

3

## Changing the Default Settings

Follow the instructions below for all selections except Printed Lines Per Page and Form Feed.

- 1 Use the cursor keys to select the desired option
- 2 Highlight the desired selection
- 3 Press **RETURN** to advance to the next line

or

Press **RELOC** to skip the other selections and confirm the changes.

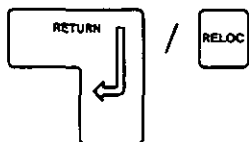

## Changing the Printed Lines Per Page or the Forms Feed Setting

- 1 Position the cursor on the line to be changed.
- 2 Press **CANCEL** (  ) twice to delete the number displayed
- 3 Type the new entry
- 4 Press **RELOC** to skip the other selections and confirm the change



# 4. DISPLAY OVERVIEW

The KX-E4500 offers a high resolution black and white reversible display screen. You can reverse the default setting of white background with black characters to black background with white characters by following the instructions on page 17. The KX-E4500 displays 80 characters across and 23 lines down. However, in typewriter mode only one line of text is displayed.

## Status Line

The first line of the display is called the Status Line. It will display a prompt to inform you of your current selections such as bold, underscore, indent, etc. The status line differs slightly in the typewriter and memory modes. Therefore, each mode will be explained separately.

4

### Typewriter Mode

The character counter is displayed in the upper right hand corner of the display in typewriter mode only. This number indicates the number of characters available between the left and right margin. As you type, this number will decrease and tell you how many characters remain.

Below is an example of how the status line is displayed in typewriter mode:

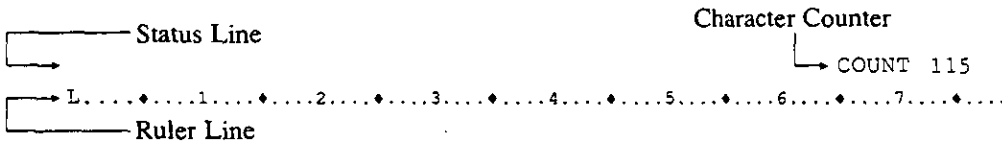



---

## Memory Mode

The text name or phrase number you are currently in is displayed at the beginning of the status line. The word "INSERT" is displayed in the center of the status line indicating that you are in the default typing mode. If this word is not displayed you are in an overtype mode and will replace existing text as you type. The COLUMN number indicates your cursor position on the ruler. The LINE number and PAGE number your cursor is positioned on are also displayed on the status line.

Below is an example of how the status line is displayed in memory mode:

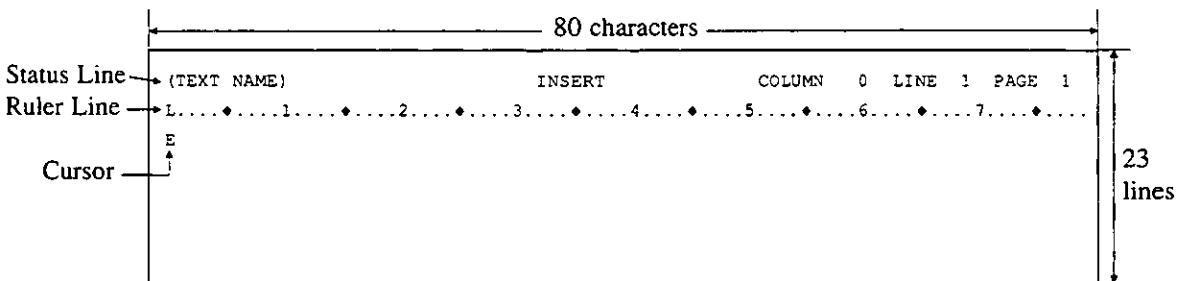

## Ruler Line

Beneath the Status Line, you will see a dotted Ruler Line which represents the current margin and tab settings. Every tenth space is marked with a numeric value (1=10, 2=20...). The margin and tab settings are indicated on the ruler line as follows:

- L Left Margin
- R Right Margin
- T Tab Stop
- H Beginning of the Hot Zone
- H<sub>T</sub> Hot Zone and Tab Stop

## Display Messages

The last line of your display is light grey regardless of the background color you select. This light grey line will display prompts to guide you through your typing projects. Refer to page 220 for a complete list of all display messages offered to you on your system.

# Display Symbols

Below is a complete list of display symbols which will appear on your screen. These symbols will not print:

- |  |   |
|--|---|
| ↵ Manual Return                                    | <b>X</b> Underscore–Continuous<br>(activated/deactivated)   |
| <b>B</b> Bold Print<br>(activated/deactivated)     | <b>X</b> Underscore–Word by Word<br>(activated/deactivated) |
| <b>C</b> Centering                                 | <b>X</b> Double Underscore<br>(activated/deactivated)       |
| <b>D</b> Decimal Tabulation                        | $\overline{X,Y,Z}$ Margin Format                            |
| <b>I</b> Insert Code (Stop Code)                   | <b>E</b> End of Text  |
| ↓ Index Command                                    | <b>L</b> Line Framing                                       |
| ↑ Reverse Index Command                            | ... Micro Space   |
| · · Half Space                                     | $\overline{E}$ Form Feed (Auto Paper Eject)                 |
| <b>M</b> Open/Close of Block Move,<br>Copy, Delete | <input type="checkbox"/> Dual–Column Command<br>Set/Reset   |
| ⇔ Left Indent                                      | $\overline{W}$ Dual–Column Command<br>change                |
| ← Permanent Backspace                              | $\overline{R}$ Mail Merge Variable                          |
| = Temporary Hyphen                                 | ∕ Mail List Record Header                                   |
| – Permanent Space                                  | $\overline{1,15,2,3}$ Line Spacing                          |
| → Tab Command                                      |   |
| ⇔ Block Indent                                     |   |

# Changing the Background Color

The KX-E4500 enables you to reverse your display. The default setting is a white background with black characters. You can change the default to black background with white characters by using the default settings menu. The new setting will remain the default until you change it.

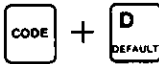

## 1 Press **CODE + D**

The screen will prompt:

DEFAULT SETTINGS			
<b>Printed Lines Per Page</b>		[54]	lines
Form Feed		[66]	lines
Lines Per Inch	5.25	6	8
Dec Tab Character	<b>Period</b>	Comma	
Low Impact	Yes	<b>No</b>	
Cursor Shape	<b>Block</b>	Underline	
Blinking Cursor	No	<b>Blink</b>	
Background Color	Black	<b>White</b>	
Auto Paper Insertion	<b>Default</b>	No	
KB Symbol Displayed	D1	D2	NY
Display Characters As	<b>Normal</b>	Bold	

RETURN to Enter, RELOC to Enter All or ESC



## 2 **DOWN ARROW** (⇩) to the Background Color line



## 3 **LEFT ARROW** (⇐) once to highlight Black



## 4 Press **RELOC** to skip the other selections

The typewriter will “beep” once to confirm and the display will be reversed. The background color can be returned to the default setting by following the instructions outlined above and selecting “white.”

# Changing the Cursor Shape

The KX-E4500 enables you to change the cursor shape from a rectangular to an underline.

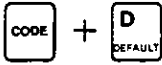

**1** Press **CODE + D**

The screen will prompt:

DEFAULT SETTINGS			
<b>Printed Lines Per Page</b>		[54]	lines
Form Feed		[66]	lines
Lines Per Inch	5.25	6	8
Dec Tab Character	<b>Period</b>	Comma	
Low Impact	Yes	<b>No</b>	
Cursor Shape	<b>Block</b>	Underline	
Blinking Cursor	No	<b>Blink</b>	
Background Color	Black	<b>White</b>	
Auto Paper Insertion	<b>Default</b>	No	
KB Symbol Displayed	D1	<b>D2</b>	NY
Display Characters As	<b>Normal</b>	Bold	

RETURN to Enter, RELOC to Enter All or ESC

4



**2** **DOWN ARROW** (↵) to the Cursor Shape line

To change the shape from a rectangle to an underline,

**3** Highlight "Underline"



**4** Press **RELOC** to skip the other selections

The typewriter will "beep" once to confirm the change.

# Turning the Cursor Blinking On and Off

The KX-E4500 enables you to display a “blinking” or “non-blinking” cursor.

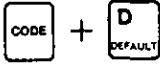

1 Press **CODE + D**

The screen will prompt:

DEFAULT SETTINGS			
<b>Printed Lines Per Page</b>		[54]	lines
Form Feed		[66]	lines
Lines Per Inch	5.25	<b>6</b>	8
Dec Tab Character	<b>Period</b>		Comma
Low Impact	Yes	<b>No</b>	
Cursor Shape	<b>Block</b>		Underline
Blinking Cursor	No	<b>Blink</b>	
Background Color	Black	<b>White</b>	
Auto Paper Insertion	<b>Default</b>		No
KB Symbol Displayed	D1	<b>D2</b>	NY
Display Characters As	<b>Normal</b>		Bold

RETURN to Enter, RELOC to Enter All or ESC



2 **DOWN ARROW** () to the Blinking Cursor line



3 **LEFT ARROW** () once to highlight No



4 Press **RELOC** to skip the other selections

The typewriter will “beep” once to confirm the change.

# Changing the KBII Symbols Displayed

The KX-E4500 is shipped with a D2 or American Daisywheel and the default setting is to display American symbols which correspond with the daisywheel shipped with your typewriter.

Daisywheels with international symbols (D1 daisywheels) are available. When using an international D1 daisywheel, you have the ability to change the characters displayed to agree with your international daisywheel by following the steps below:

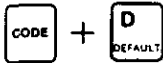

**1** Press **CODE + D**

The screen will prompt:

DEFAULT SETTINGS			
<b>Printed Lines Per Page</b>		[54] lines	
Form Feed		[66] lines	
Lines Per Inch	5.25	<b>6</b>	8
Dec Tab Character	<b>Period</b>	Comma	
Low Impact	Yes	<b>No</b>	
Cursor Shape	<b>Block</b>	Underline	
Blinking Cursor	No	<b>Blink</b>	
Background Color	Black	<b>White</b>	
Auto Paper Insertion	<b>Default</b>	No	
KB Symbol Displayed	D1	<b>D2</b>	NY
Display Characters As	<b>Normal</b>	Bold	

RETURN to Enter, RELOC to Enter All or ESC



**2** **DOWN ARROW** (⇩) to the KB Symbol Displayed line



**3** **LEFT ARROW** (⇐) once to select D1 for international symbols



**4** Press **RELOC** to skip the other selections

The typewriter will “beep” once to confirm the change.

Although the KBII characters will display international symbols, these symbols will not print until you insert a D1 daisywheel in the typewriter.

# Changing all Characters to Display as Bold

The line "Display Characters As" enables you to display all characters in a bold or darker display and characters to be printed in bold face will be displayed in a normal or lighter on the display.

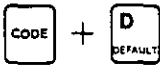

1 Press **CODE + D**

The screen will prompt:

DEFAULT SETTINGS			
<b>Printed Lines Per Page</b>		[54]	lines
Form Feed		[66]	lines
Lines Per Inch	5.25	<b>6</b>	8
Dec Tab Character	<b>Period</b>		Comma
Low Impact	Yes	<b>No</b>	
Cursor Shape	<b>Block</b>		Underline
Blinking Cursor	No	<b>Blink</b>	
Background Color	Black	<b>White</b>	
Auto Paper Insertion	<b>Default</b>		No
KB Symbol Displayed	D1	<b>D2</b>	NY
Display Characters As	<b>Normal</b>		Bold

RETURN to Enter, RELOC to Enter All or ESC

4



2 **UP ARROW** (↑) once to quickly advance to the line, Display Characters As



3 **RIGHT ARROW** (→) once to highlight Bold



4 Press **RELOC** to skip the other selections

The typewriter will "beep" once to confirm the change.

# Embed

The symbols listed on the previous page are displayed when a feature is turned on or off. As a result, your text will shift one character to the right for each screen symbol. Many times it is difficult to visualize how your text will look with these symbols on screen. Therefore, the KX-E4500 enables to embed (hide) these non-printable symbols so that you can get a better idea of how your printed text will look. This feature is extremely useful when using line framing to box information because the lines are not visible until the display symbols are embedded.

4

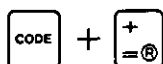

- Press **CODE + =**

## Embedding Non-Printable Symbols

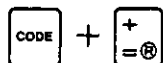

- Press **CODE + =** again

## Displaying Non-Printable Symbols



# Controlled Printer Movement

Controlled Printer Movement enables you to advance the printhead as you type on the display without printing. This feature is available to you in both the typewriter and memory modes.

## Typewriter Mode

When using controlled printer movement in the typewriter mode, the line displayed will print when the KX-E4500 automatically returns at the end of a line or the following keys are pressed: **RETURN**, **TAB**, **DEC TAB**, **CENTER**, **PRINT**, **IND**, **CODE + E**, **CODE + F**, **CODE + K**, or **CODE + P**.

## Memory Mode

When using controlled printer movement in the memory mode, the printhead will move as you type without printing. When you reach a page end or you press **CODE + E** to insert a page break. The system will return to the top of the paper but it will not eject it from the typewriter.

### Activating Controlled Printer Movement

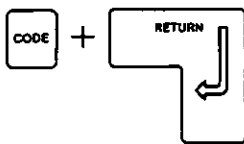

- Press **CODE + RETURN**

### Deactivating Controlled Printer Movement

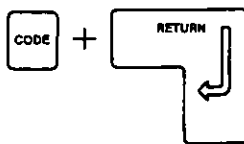

- Press **CODE + RETURN** again

# 5. USING THE TYPEWRITER

This section will introduce you to the fundamental operations of the KX-E4500. Read through it and do the exercises to familiarize yourself with each operation.

## Help

The **HELP** key has been designed as a quick reference of all coded functions. The **HELP** key will display a list of coded functions in both the typewriter and memory modes.

The **HELP** key also doubles as a margin release key in typewriter mode; therefore, the **HELP** key must be pressed twice to access a help menu in the typewriter mode.

### Accessing Help in the Typewriter Mode

- Press the **HELP** key twice
- Press **RETURN** to advance to each screen  
or
- Press **EXPR** to return to the first help menu

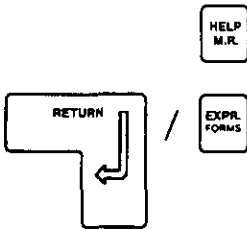

### Accessing Help in the Memory Mode

- Press the **HELP** key once
- Press **RETURN** to advance to each screen  
or
- Press **EXPR** to return to the first help menu

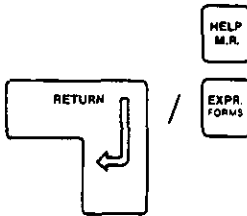

### Exiting the Help Menu

- Press the **HELP** key again



# Automatic Paper Insertion

The Panasonic typewriter is pre-programmed to insert your paper seven (7) lines from the top of the page pulling the paper bail release lever toward you. You have the ability to change the insertion position to meet your requirements (e.g., below letter head paper). The insertion position you set will remain until you change it.

The KX-E4500 also enables you to reset the insertion position to the default of seven lines from the top of the paper quickly and easily.

## Changing the Paper Insertion Position

- 1 Place your paper against the paper support guide with the left edge of the page aligned with 0
- 2 Pull the Paper Bail Release Lever towards you until the paper is inserted
- 3 Press **RETURN**, **INDEX** ( $\downarrow$ ), or **REVERSE INDEX** ( $\uparrow$ ) to position the paper at the desired insertion point
- 4 Press **CODE** + **A**

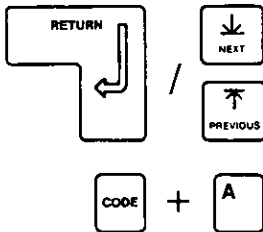

## Resetting the Default Paper Insertion Position

- 1 Press **CODE** + **D**
- 2 **DOWN ARROW** ( $\downarrow$ ) eight times to reach the Auto Paper Insertion line
- 3 Highlight Default
- 4 Press **RELOC** to skip to the other selections

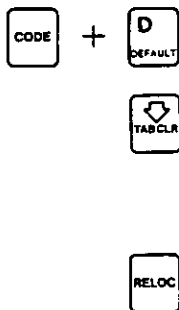

The typewriter will “beep” once to confirm the change.

## Automatic Paper Eject

The KX-E4500 has been pre-programmed for standard 8½×11" paper (66 lines), and will eject the paper based on that setting. If you are using legal or ledger size paper (longer than 11"), the paper will not eject fully from the typewriter unless you change the default form feed setting (see page 11).

### Automatically Ejecting the Paper

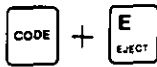

- Press **CODE + E**

## Index ( ↓ ) and Reverse Index ( ↑ )

5

The **INDEX ( ↓ )** key allows you to advance the paper a ½ line toward the bottom of the page. The **REVERSE INDEX ( ↑ )** key allows you to advance the paper a ½ line towards the top of the page.

These keys are useful when typing subscripts and superscripts. You will also use them in conjunction with other features discussed later in this manual.

The scientific equation for water is H<sub>2</sub>O.

To type this, you would first enter "H"



- 1 Press **INDEX ( ↓ )** and type "2"



- 2 Press **REVERSE INDEX ( ↑ )** to reposition the printer on the actual typing line and type 0

## Micro Index

Micro Indexing moves the printer vertically in increments of 1/48th of an inch up or down on the paper. This is extremely useful when aligning the printer with pre-printed forms.

### Micro Indexing

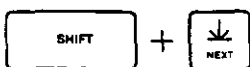

- Press **SHIFT + INDEX ( ↓ )** or **SHIFT + REVERSE INDEX ( ↑ )**

OR

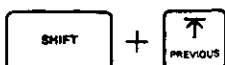

The **SHIFT** key must be held down while pressing either key.

**NOTE:** Micro Indexing is not stored in the correction memory.

# Margins and Tabs

Because there are no preset margins and tabs, the KX-E4500 enables you to set margins and tabs to meet your requirements. A maximum of 28 tab stops can be set. The "Ruler" line discussed on page 15 displays the current margin and tab settings.

The KX-E4500 enables you to store three frequently used margin formats (margins, tabs, and hot zone) referred to as rulers under "X", "Y", or "Z." These formats can be recalled at any time and are available in addition to the current margin and tab settings.

The following keys are used to set and clear margin and tab settings:

<b>L.MGN</b>	Left Margin
<b>R.MGN</b>	Right Margin
<b>TAB SET</b>	Tab Settings
<b>TAB CLR</b>	Clears Tab Settings
<b>CODE + R.MGN</b>	Hot Zone
<b>M.R.</b>	Margin Release

5

## Setting Margins and Tabs

1 Position the mode selector on **NORM**

SPACE BAR

2 Press **SPACE BAR**

This moves the printer toward the right. To set the left margin to the left of the current one, press **M.R.** and **BACKSPACE** to reach the desired position.



3 Press **L.MGN**

SPACE BAR

4 Press **SPACE BAR** to position the printer at a desired Tab stop



5 Press **TAB SET**

Repeat the last two steps for each tab stop required (max. 28).

SPACE BAR

6 Press **SPACE BAR** to reach the desired right margin setting

To set the right margin to the right of the current one, press **M.R.** to space beyond the current margin setting to the desired position.



7 Press **R.MGN**

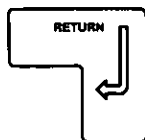

8 Press **RETURN**

---

## Clearing a Tab Stop



1 **TAB** to the desired tab setting



2 Press **TAB CLR**

## Clearing All Tabs and Retaining Margins



1 **SPACE** or **TAB** to the first tab position

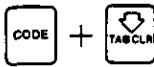

2 Press **CODE + TAB CLR**

5

## Clearing All Margins and Tabs

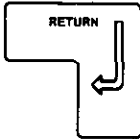

1 Press **RETURN**

This positions the printer at the left margin. (The printer must be at the left margin to clear all margin and tab settings.)

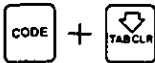

2 Press **CODE + TAB CLR**

The printer will move to the far left, clearing all existing margins and tabs.

---

## Adjustable Hot Zone

The Hot Zone represents the number of spaces between the bell and the right margin. It is preprogrammed for 0.7 of an inch (7 spaces in 10 pitch) from the right margin. You may change the setting to within one inch of the right margin.

### Setting the Hot Zone

- 1 Position the MODE selector on **NORM**
- 2 Press **SPACE BAR** or **TAB** to position the printer at the right margin
- 3 **BACKSPACE** to the required new bell position (maximum 10 spaces from the right margin)
- 4 Press **CODE + R.MGN**

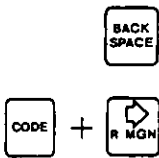
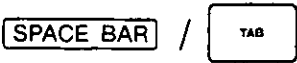

### Margin and Tab Exercise

For the first exercise, set your typewriter as indicated below:

The paper guide is at 0  
The pitch selector is set at 10 (PICA)  
The daisywheel in the unit is 10 pitch  
The MODE selector is on NORM

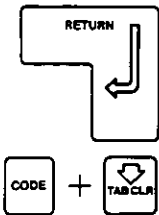

- 1 Press **RETURN**
- 2 Press **CODE + TAB CLR**
- 3 Set the margins and tabs below:

Left margin	15
Tabs	30, 45, 60
Right margin	74

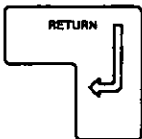

- 4 Press **RETURN**

Your Counter will show the number of characters available on the writing line.

# Store Ruler

To eliminate the tedious task of manually setting margins, tabs and hot zones with each new document, the KX-E4500 allows you to store three frequently used margin formats in memory. These formats are stored in locations "X", "Y", and "Z" and can be recalled for use when typing in or out of text memory.

Follow the instructions below and store the margin format that you set in the last exercise into memory.

## Storing Margins and Tabs

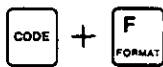

- 1 Press **CODE + F** (Margin Format)

Your display will prompt:

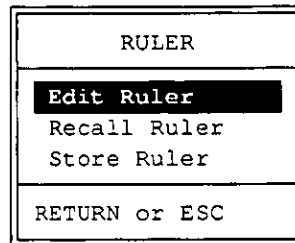

- 2 Press **S** (for Store Ruler)

Your display will prompt:

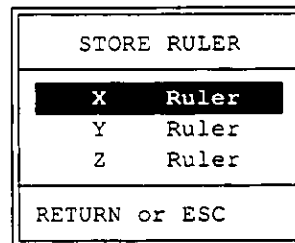

- 3 Press the letter **X** (**Y** or **Z**)

The typewriter will "beep" once to confirm that the ruler has been stored.



## Exercise

Store the following formats into Memory.

### Format Y

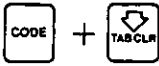

1 Press **CODE + TAB CLR** to clear existing margins and tabs

2 Set the margins and tabs below:

Left margin	11
Tabs	20, 33, 45, 54
Right margin	64

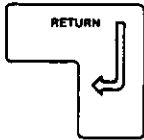

3 Press **RETURN**

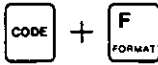

4 Press **CODE + F**



5 Press the letter **S**



6 Press the letter **Y**

### Format Z

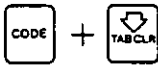

1 Press **CODE + TAB CLR** to clear existing margins and tabs

2 Set the margins and tabs below:

Left margin	11
Tabs	26, 39, 49, 59
Right margin	66

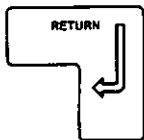

3 Press **RETURN**

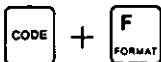

4 Press **CODE + F**



5 Press the letter **S**



6 Press the letter **Z**

# Recall Ruler

Now that you have three margins stored into memory, lets learn how to recall them for future use.

## Recalling Margins and Tabs

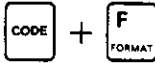

- 1 Press **CODE + F** (Margin Format)

Your display will prompt:

RULER
<b>Edit Ruler</b>
Recall Ruler
Store Ruler
RETURN or ESC



- 2 Press the letter **R** (for Recall Ruler)

Your display will prompt:

RECALL RULER
<b>X Ruler</b>
Y Ruler
Z Ruler
RETURN or ESC



- 3 Press the letter **X (Y or Z)**

The margin format has been recalled, and is ready for use.  
It's that simple!

## Edit Ruler

The typewriter mode enables you to edit margin and tab settings in two ways:

- (A) Set the new margins and tabs and store them over the current format by following the instructions outlined on pages 27 and 30.
- (B) Select "Edit Ruler" from the format menu and display the margin and tab format on the ruler line before editing.

In the text memory mode (margins and tabs are ignored in phrase memory), item "B" above is the only way to edit margin and tab settings.

The Edit Ruler selection enables you to edit the current margin and tab settings as well as those stored under formats "X", "Y", and "Z." The Edit Ruler procedure is exactly the same when selected in either the typewriter or text memory mode as outlined below:

- The printhead automatically moves beyond the left margin setting to the end of the platen.
- Margin Release (M.R.) is not necessary in the Edit Ruler mode to bypass the current left and right margin setting.
- The printhead moves along the ruler line when you press the **SPACE BAR** or the **FWD→** key.
- The same keys used to set new margins, tabs and hot zone outlined on page 27 are also used when editing the ruler.
- It is not necessary to clear the current left and right margin, or hot zone before setting a new one. When the new left or right margin, or hot zone is set, the old setting will automatically clear.
- Unwanted Tabs are cleared from the ruler line by positioning the cursor on the tab (represented by the letter "T") and pressing **TAB CLR**.

The following keys are used to move to the desired position on the ruler line:

- FWD-** Moves the cursor one character to the right
- SPACE BAR** Moves the cursor one character to the right
- BACKSPACE** Moves the cursor one character to the left
- TAB** Moves the cursor to the next Tab position
- EXPR** Moves the cursor to the beginning of the ruler
- RELOC** Moves the cursor to the right margin

### Editing Margins and Tabs

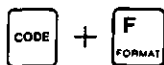

1 Press **CODE + F**

Your display will prompt:

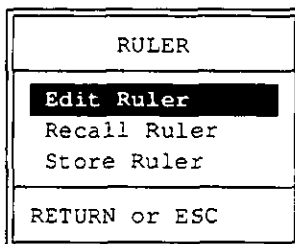

2 Press **E** (for Edit Ruler)

Your display will prompt:

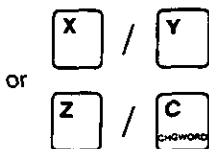
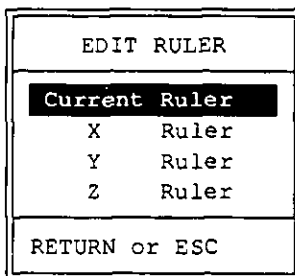

3 Press **X, Y, Z, or C** (for Current Ruler)

Your cursor will be positioned at 0 on the ruler line.

4 Make the desired changes

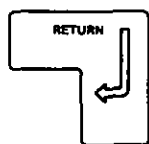

5 Press **RETURN** to enter

## Typing on Display in the Typewriter Mode

In typewriter mode, only one line of text is displayed when typing with the mode selector set on **DISP** or **JSTFY**. As you type, your text will appear on the third line of the screen. The cursor will indicate exactly where the next character you type will appear.

When typing out of memory, only the insert typing mode is available. Therefore, if you backspace and type in the middle of text, the characters will insert to the left of the cursor and move the existing text to the right. The **RELOC** key can be used to position the cursor at the end of the line. Below is a list of keys used to move the cursor when typing on display in the typewriter mode.

<b>FWD→</b>	Advances the cursor to the right
<b>BACKSPACE</b>	Moves the cursor to the left
<b>RELOC</b>	Advances the cursor to the end of the line
<b>EXPR</b>	Moves the cursor to the beginning of the line

The KX-E4500 will automatically return and print the line displayed when typing in **DISP** and **JSTFY** modes. The automatic return is triggered when a character is typed following a space in the hot zone. (The hot zone is the area between the bell and the right margin.)

The line displayed will also print when one of the following keys is pressed: **RETURN**, **TAB**, **DEC TAB**, **CENTER**, **PRINT**, **⇧IND**, **CODE + E**, **CODE + F**, **CODE + K**, or **CODE + P**.

## Corrections

The KX-E4500 offers many ways to insure that your work is letter perfect. In addition to the display, which enables you to correct errors before they are printed, the KX-E4500 has a 1,000 character correction memory (approximately ½ a page) which makes correcting errors a simple task. There are even two methods of manual correction available to correct errors that are made outside of the correction memory.

In the typewriter mode, two dedicated keys are available to delete errors:

**CANCEL (⊗)** Deletes one character at a time to the left of the printhead. If the printhead is located at the left margin, the **CANCEL (⊗)** key will move the printhead to the end of the previous line.

**QUICK ERASE** Deletes one word at a time to the left of the cursor.

In the memory mode it is possible to delete an entire line by using **CODE + QUICK ERASE**.

Below is a list of keys used to make corrections.

**SPACE BAR** Used to position the printer one space to the right of the incorrect character.

**BACKSPACE** Used to position the printer one space to the right of the incorrect character. It also advances to the previous line in correction memory when pressed at the left margin.

**REVERSE INDEX (↑)** Advances by ½ line outside the correction memory when pressed at the left margin.

**EXPR** Moves the printer to the beginning of the line without line spacing.

**RELOC** Moves the printer to the last printed character on the page, or to the last manual return.

**CODE + CANCEL (⊗)** Enables the printer to advance beyond the correction memory.

**CODE + PRINT** Enables you to retype errors into the correction memory without printing (adding more ink to the paper.)

---

## Within the Correction Memory

The **BACKSPACE** key is used to advance to a previous line within your correction memory. If the **INDEX** (↓) or **REVERSE INDEX** (↑) keys are used to advance to a line within correction memory, you will not be able to relocate.

### Correcting Errors on the Same Line

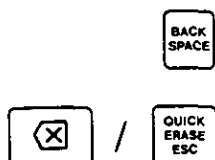

- 1 **BACKSPACE** to position the printer one space to the right of the character you wish to delete
- 2 Press **CANCEL** (X) to delete one character at a time  
OR  
Press **QUICK ERASE** to delete one word at a time
- 3 Type the correct character(s)

### Exercise

Set the mode selector on **NORM**, and type the following sentence.  
Be sure to include the errors, and do not **RETURN** at the end of the line.

The KX-E4500 has sohpnsticated junctions but is easy to yse.

Using the steps outlined above, make the following corrections:

Change: "sohpsticated" to "sophisticated"  
"junctions" to "functions"  
"yse" to "use"

### Correcting Errors on Previous Lines

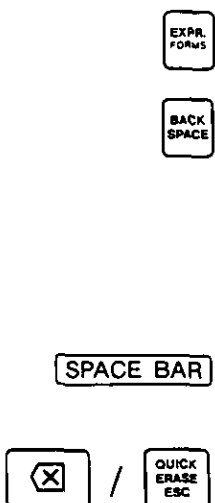

- 1 **EXPR** to the beginning of the current line
- 2 Press **BACKSPACE** to position the printer on the line containing the error  
  
You may also position the printer on the desired line by pressing **CODE + INDEX** (↓) or **CODE + REVERSE INDEX** (↑).
- 3 **SPACE** to position the printer one character to the right of the error
- 4 Press **CANCEL** (X) to delete one character at a time  
OR  
Press **QUICK ERASE** to delete one word at a time

## Out of the Correction Memory

When you reach the last line in the correction memory, the KX-E4500 will beep and you will be unable to use the **BACK SPACE** or **CODE + REVERSE INDEX** (↑) keys to advance to the previous line. Two methods of correction are available outside of the correction memory; the No Print method and Manual Correction.

### Using the No Print Method

The No Print method enables you to retype errors into the correction memory without re-printing them. This feature is especially useful when correcting errors typed in proportional spacing (PS), or in the JSTFY mode.

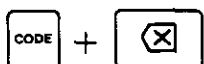

**1** Press **CODE + CANCEL** (⊗) to exit the correction memory



**2** Press **REVERSE INDEX** (↑) to position the printer on the desired line

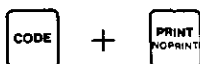

**3** Press the **CODE + PRINT** key

The message "NOPRINT" will appear.

**4** • If the text was typed in 10, 12, or 15 pitch:

Position the mode selector to **NORM**

**SPACE** to position the printer on the error and retype the incorrect characters

• If the text was typed in **PS** pitch:

Retype from the beginning of the line to the error

• If the text was typed in **JSTFY** mode:

Retype the entire line until the printer automatically returns to the next line

SPACE BAR



Press **CANCEL** (⊗) until all characters are deleted from the display and the printer advances to the end of the previous line



**BACKSPACE** to position the printer to the right of the error





- 5 Press **CANCEL** (X) to delete one character at a time  
or  
Press **QUICK ERASE** to delete one word at a time

The prompt "NOPRINT" will disappear.

- 6 Retype the correct character(s)



- 7 Press **RELOC**

### Making Manual Corrections

Manual Correction is ideal for correcting one or two errors outside of the correction memory.

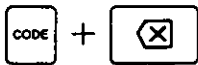

- 1 Press **CODE + CANCEL** (X) to advance beyond the correction memory

The printer will automatically move to the left margin



- 2 Press **REVERSE INDEX** (↑) to position the printer on the line containing the error



- 3 **SPACE** to position the printer directly over the error

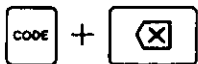

- 4 Press **CODE + CANCEL** (X)

- 5 Retype the incorrect character

This will lift the character off the paper.

- 6 Type the correct character

- 7 Repeat the steps outlined above for each incorrect character on the same line



- 8 Press **RELOC**

This repositions the printer at the last printed character or RETURN.

## Exercise

Type the following exercise including the errors using the format "X" and the mode selector set on NORM. When finished, use the correction procedures you have just learned. Be sure to make the corrections within the correction memory first, and then make the corrections out of correction memory.

Distantly related to the opossum, the Koala bear is only 3/4 of an inch long at birth and weighs only 1/5 of an ounce. Usually only one Koala is born at a time, with the mother bearing young only every other year.

*infant* — The infznt will remain in its mother's pouch until it is ready to emerge at six months of age. It will then  
*cling* — climg to its mother's back until it is a year old.

*weigh* — When fully grown, it will stand about two feet high and may wieth as much as 33 pounds. At the age of four, the animal will have attained full sexual maturity and its life span may be as long as 20 years. *tall*

When the Koala is ready to strike out on it's won it will find its own eucalyptus tree, whose leaves are almost its only food. Only on rare occasions will it leave the tree, as when it seeks another tree to tkae up new residence. *its own* *take*

*clawed* — The Koala is suited for climbing; as all four of its sharp clawde feet are made for grasping. During the day the Koala sleeps, usually curled up inconspicuously in the crotch of a tree, and feeds only at nighttime. *nighttime*

At one time, the Koala a native of Australia, was severely threatened with extinction. Now the Australian governemth is taking drastic stesp to insure its survival.

*steps*

*government*

## Correcting Errors on Display in the Typewriter Mode

As mentioned earlier, when the mode selector is set on **DISP** or **JSTFY**, the screen will allow you to view one line of text before it is printed on paper. Since most operators can sense when an error has been made, having the mode selector on **DISP** or **JSTFY** provides the opportunity to correct errors before they are printed.

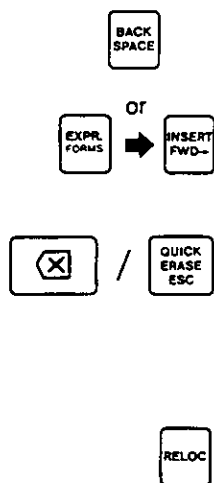

- 1 Press **BACKSPACE** to position the cursor one space to the right of the error  
OR  
Press **EXPR** to advance to the beginning of the line and **FWD→** to position the cursor one space to the right of the error
- 2 Press **CANCEL** (**X**) to delete one character at a time  
OR  
Press **QUICK ERASE** to delete one word at a time
- 3 Type the correct character
- 4 Press **RELOC** and continue typing

### Exercise

- 1 Set the mode selector to **DISP**
- 2 Recall margin format "X"
- 3 Type the following sentence including the errors. Do not press **RETURN** at the end of the line.
- 4 Make the necessary corrections as outlined above.

Errors are corrected before they print on paper.

# 6. AUTOMATED TYPING FEATURES

## Caps Lock

The Caps Lock feature enables you to type capital letters and numbers at the same time without having to shift back and forth from upper to lower case. The **LOCK** key's indicator light will flash when this feature is activated.

### To Activate Caps Lock:



- Press **CODE + LOCK**

Every letter you type will be in CAPITAL LETTERS, when you use the number keys you will not get the traditional shift symbols, you will get the numbers.

### To Deactivate Caps Lock:

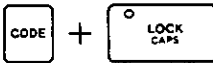

- Press **CODE + LOCK** again

The indicator light on the lock key will no longer flash.

6

## Bold Print

This feature instructs the printer to strike each character twice, this will “highlight” or emphasize certain words for you.

When bold print is activated, the word **BOLD** will appear on the status line. When typing on display, in addition to the status line prompt, the symbol **B** will appear indicating where bold print was turned off and on. The text between these symbols will be printed in bold face.

### To Activate Bold Print:

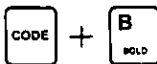

- Press **CODE + B** and type the word(s) to be highlighted.

### To Deactivate Bold Print:

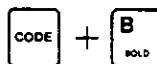

- Press **CODE + B** again

# Underscore

The KX-E4500 offers you three ways to underscore; Continuous, Word by Word, and Double.

The appropriate underscore symbol shown below will appear on the status line when underscore is activated.

XX XX      Continuous Underscore

XX XX      Word by Word Underscore

XX XX      Double Underscore

When typing on display, in addition to the status line prompt, the following underscore symbols “X”, “X” or “X” will appear indicating where underscore was turned off and on. The text between these symbols will be underscored.

## Continuous Underscore

To Activate:



- Press XXX

Both the characters and spaces will be underscored.

To Deactivate:



- Press XXX again

### Example

This is continuous underscore.

---

## Word by Word Underscore

To Activate:

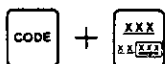

- Press **CODE** + **XXX**

Only words will be underscored.

To Deactivate:

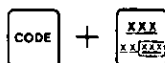

- Press **CODE** + **XXX** again

### Example

This is word by word underscore.

6

## Double Underscore

To Activate:

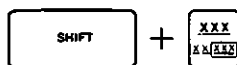

- Press **SHIFT** + **XXX**

Both characters and spaces will be underscored with a double line.

To Deactivate:



- Press **SHIFT** + **XXX** again

### Example

This is double underscore.

# Centering

There are four ways to center information; between margins, over a point, between tab stops and aligned at the right margin.

The word CENTER will appear on the status line when centering in the typewriter mode. The symbol **C** will appear on the display when centering in the phrase or text memory mode.

## Between Margins

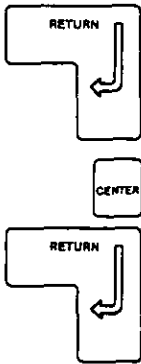

- 1 Press **RETURN** to position the printer at the left margin
- 2 Press **CENTER** and type the information
- 3 Press **RETURN** to print

### Example

*Lm*  
X

*Rm*  
X

Center (Your Name)  
Center Panasonic  
Center Electronic Typewriter

6

## Over a Point

SPACE BAR

- 1 Press the **SPACE BAR** to move your printer to the desired position
- 2 Press **CENTER** and type the information
- 3 Press **TAB** or **RETURN** to print

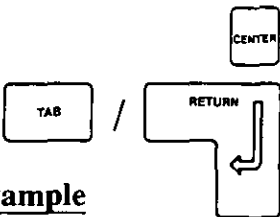

### Example

*Lm*  
X

*T*  
X

*T*  
X

*T*  
X

*Rm*  
X

Center  
SPACE  
Panasonic

## Between Tab Stops

- 1 Choose the tabs you would like to center between
- 2 **TAB** to the left stop position
- 3 Press **CENTER** and type the information
- 4 Press **RETURN** or **TAB** to print

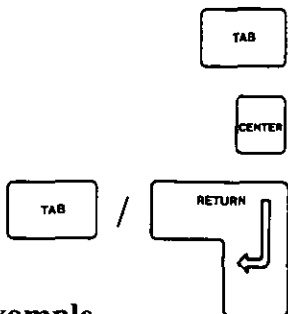

### Example

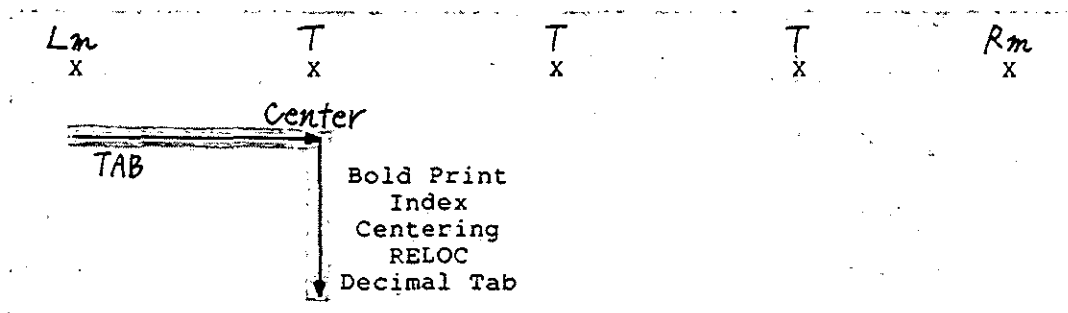

6

## Aligned at the Right Margin

- 1 **TAB** to the right margin
- 2 Press **CENTER** and type the information to be aligned
- 3 Press **RETURN** to print

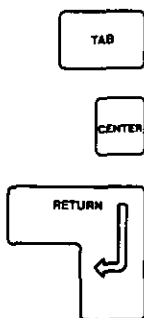

### Example

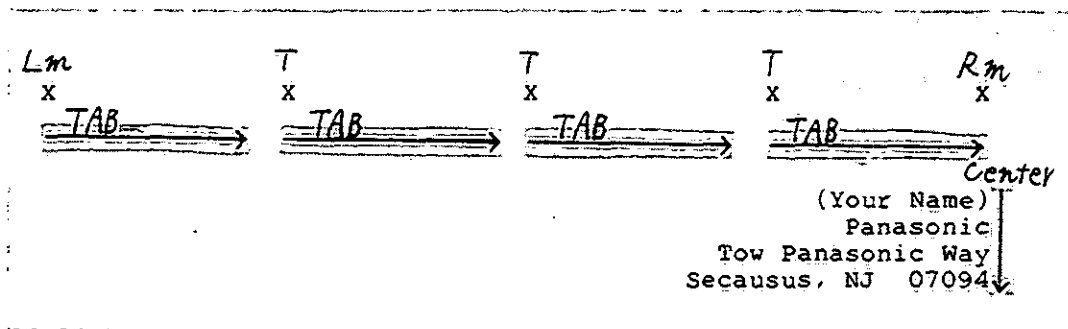



# Indent

The KX-E4500 offers two forms of indent: Left Indent and Block Indent. Left Indent allows you to set a temporary left margin and eliminates the need to TAB before typing each indented line. Block Indent automatically indents the left and right margin evenly. When either INDENT is activated, the word INDENT will appear on the status line. When typing on display, an indent symbol “≡” or “≡” will appear on the ruler line to indicate where the indent was set. When typing in text memory, in addition to the symbols on the status and ruler line, an indent symbol will also appear at the beginning and at the end of the indented text.

The display symbol for each indent is shown below:

≡ Left Indent

≡ Block Indent

The indent feature is not available when typing in phrase memory.

## Left Indent

Left Indent will provide indentation from the left side only.

### Indenting the Left Side of the Text

SPACE BAR / TAB

≡ IND  
≡ IND

≡ IND  
≡ IND

**1** SPACE or TAB to the desired point of indentation

**2** Press ≡ IND to activate the command

**3** Type the text

**4** Press ≡ IND to deactivate the command

## Left Indent Exercise

Type the following exercise using the format "X" and the mode selector set on JSTFY.

Lm                      T                      T                      T                      Rm  
X                      X                      X                      X                      X

Below is the revised company policy regarding the use of limousine services for business travel.

*Tab* → Company employees may use Westerly Limo Service and have the charges billed directly to the company. If a different limo service is used, a paid receipt must accompany your expense report.

*Indent* →

*Indent* ←

## Block Indent

Block indent automatically indents the right margin in proportion to the left margin. This feature creates a uniform appearance and centers the text between margins.

The temporary margins set with block indent must be more than one inch apart.

### Indenting Both Sides of the Text

SPACE BAR / TAB

CODE + IND

1 SPACE or TAB to the desired point of indentation

2 Press CODE + IND to activate the command

The same number of spaces indented from the left will automatically be indented from the right.

3 Type the text

CODE + IND

4 Press CODE + IND to deactivate the command

## Block Indent Exercise

Type the following exercise using the format "X" and the mode selector set on JSTFY.

Lm T T T Rm  
X X X X X

If Westerly Limo Service is not available at the time of your request, please contact the company's travel agency.

Tab → Utopia Travel is located on  
the third floor of the north  
administration building. You  
may contact them on extension  
1234. ← Code # Indent

If you have any questions concerning business travel, please let us know.

## Decimal Tabulation

The **DEC TAB** key advances the printer to the next tab position. Alpha or numeric characters are aligned to the left of that tab position. A period (decimal point) or comma is aligned at the tab stop. Characters following the period or comma are positioned to the right of the tab position.

Because DEC TAB aligns all characters before a period or a comma to the left of the tab position, it is ideal for whole numbers or characters that require a flush right appearance. For statistical typing, DEC TAB simplifies the tedious task of manually aligning a column of numbers.

The word DECTAB will appear on the status line when used in the typewriter mode. The symbol "D" will appear on the display when typing in text memory. The DEC TAB feature is not available when typing in phrase memory.

For statistical typing in foreign countries, numbers are aligned at the comma position instead of the decimal point. If this is required, you may change the alignment character by accessing the default settings menu (see page 12).

## Using Decimal Tabulation

### 1 Set tab stop

Remember, set the tab stop in the position you want the decimal point to appear.

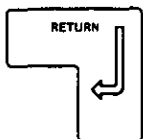

### 2 Press RETURN

This will bring the printer back to the Left Margin.



### 3 Press DEC TAB

### 4 Type the numbers, decimal point, or text to be aligned

The printer backtraces once for every character entered before the decimal point.



### 5 Press DEC TAB to advance to the next tab stop

### 6 Repeat steps 4 & 5 until you have completed all your entries

### 7 Press RETURN

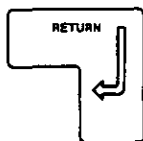

Begin typing the second line of information.

### Example

Lm X	T X	T X	T X	Rm X
	<u>DEC TAB</u>	<u>DEC TAB</u>	<u>DEC TAB</u>	
	123.46	347.91	156.98	
	12.10	13.06	31.28	
	1234.56	7654.23	4851.12	
	.12	.24	.36	

# Temporary Hyphen (Soft Hyphen)

A Temporary Hyphen enables you to hyphenate words that fall within the hot zone (between the bell and the right margin). A Temporary Hyphen triggers an Auto Return and should only be used in the **DISP** or **JSTFY** typing modes. Because the Temporary Hyphen enables you to fit more characters on a line, it gives the right margin a less ragged appearance. The symbol “=” will appear when typing on display.

## Inserting a Temporary Hyphen

- 1 Type until you hear the “beep” (bell) as you near the end of the line
- 2 Press **CODE** + **HYPHEN** (-) at the desired hyphenation point

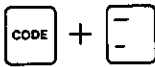

The printer will automatically return to the left margin.

### Exercise

Type this exercise below using the “Y” ruler and the mode selector on **DISP**.

Soft hyphens are entered in the hot zone to prevent long words from causing extremely ragged margins on the right side of the page. However, remember to use the CODE key before you depress the hyphen key. This tells the typewriter to return at the next character typed.

Code + Hyphen

## Permanent Space

Permanent Space enables you to type a space between two words within the hot zone, without triggering an auto return. This feature is ideal when typing proper names or dates which should appear on the same line.

### Entering a Permanent Space

- 1 Type until you hear the “beep” (bell) as you near the end of the line
- 2 Press **SHIFT + SPACE BAR** between the two words that you want to appear on the same line

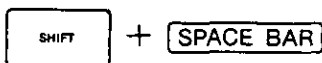

### Exercise

Type the following text using the permanent space feature where indicated.

6

- Set the mode selector on **DISP** and use the “Y” ruler.

Permanent spaces prevent names or dates from being separated. In instances such as San Francisco, Ca. or New York, N.Y. or dates such as September 30, 1989 you may instruct the typewriter to never separate these characters or numbers onto different typing lines.

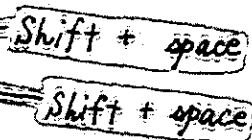

## Micro Space

A micro space allows you to move the printhead  $\frac{1}{6}$ th of a space in 10 pitch. The symbol “...” will appear when typing on display.

### Entering a Micro Space



- Press **CODE + SPACE BAR**

# Permanent Backspace

When typing in memory or in a display mode, a permanent backspace is required to instruct the system to print one character over another. Using left arrow or backspace alone when typing on display will only insert the character in front of the one you are trying to overlap.

Although it is possible to print one character over another in the typewriter (NORM) mode, use the Permanent Backspace feature to include both characters in the correction memory. This enables you to correct both characters automatically. For instance, if you type 0 without using the Permanent Backspace feature, you will only be able to correct the slash (/), not the zero (0).

## Entering a Permanent Backspace

**1** Type the first character

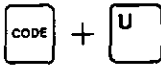

**2** Press **CODE + U**

If typing on display, a small arrow pointing to the left (←) will appear.

**3** Type the character you want to print over the first entry

## Exercise

The following exercise incorporates the function key operations you have just learned and gives you the opportunity to use them in a standard letter.

To begin this exercise, recall margin format "Y" and set your MODE selector on DISP.

(Today's Date)

15 Hunts Lane  
Weston, CT 06883

Right  
Align  
Centering

Mr. C. C. Charles  
19 Treaty Road  
Valley Forge, PA 08901

Dear Mr. Charles:

In response to your recent inquiry regarding our new line of customized designer wall coverings, I am enclosing the samples you had requested, for your approval. Outlined below is the quantity pricing for each of the patterns we discussed.

Pattern	Retail	1-5	6-9	10 +
Wheat	36.70	29.90	25.40	21.20
Willow	38.40	31.55	26.80	22.60
Tulip	44.60	37.80	34.50	30.90
DISCOUNT	8.0%	7.5%	7.5%	8.0%

These prices are based upon the length and width of one (1) standard roll. Each of the patterns we discussed may be custom colored to meet your personal requirements.

If you have any questions, please let me know. I look forward to working with you and thank you for considering our products.

Sincerely,

(Your Name)  
Professional Home Designs



# 7. MEMORY

---

Memory works very much like your file cabinet; allowing you to store information in separate files and even in separate drawers.

The KX-E4500 gives you three separate storage areas or drawers. Two of these storage areas, **Phrase Memory** and **Text Memory**, are located in the internal memory of the typewriter.

**Phrase Memory**—Phrase Memory is designed to store frequently used addresses, short paragraphs, and text which will print as a header or footer. The information is stored in files numbered from 1 through 99.

**Text Memory**—Text Memory is used to store more lengthy documents, such as letters and reports. These files are stored by name.

Your typewriter comes standard with 25,000 characters (approx. 12 to 15 pages) of internal memory that can be expanded to 57,000 characters (approx. 28 to 30 pages). The internal memory can be divided between phrase and text memory to meet your requirements. If desired, you can use all your internal memory to create one file. The choice is yours. When all the internal memory is used, the system will prompt, "MEMORY FULL!" You then have the ability to store your text files to disk and clear the internal memory for future use.

The third storage area is the Disk Drive. The standard 3½" floppy disk drive, located on the left side of the typewriter, allows you to store 720,000 characters on each disk. This gives you virtually unlimited storage capabilities.

The following pages contain instructions on how to use both the memory, and the text editing features that make memory so useful.











## Typing in Memory

When typing in phrase or text memory, the word **INSERT** will be displayed on the status line. Insert is the default setting when typing in memory.

Insert enables you to add characters at the cursor position by simply typing the additional characters or words. Your text will shift to the right as each character is entered, automatically reformatting the text to conform with the current margins.

The overtype mode is accessed by pressing the **INSERT** key. The word **INSERT** will no longer display on the status line. Overtyping enables you to type over existing text and replace it with newly typed characters.

The arrow keys are used to move the cursor when typing in memory. While it is true that the **BACKSPACE** key will allow you to move one character to the left in both the typewriter and memory mode. The **FWD→** key becomes the **INSERT** key in memory mode. Below is a list of keys used to move the cursor when typing in memory:

<b>Right Cursor</b> (  )	One character to the right
<b>Left Cursor</b> (  )	One character to the left
<b>Down Cursor</b> (  )	Down one line
<b>Up Cursor</b> (  )	Up one line
<b>EXPR</b> (Express)	Beginning of the text
<b>RELOC</b> (Relocate)	End of the text
<b>CODE + Right Cursor</b> (  )	End of line
<b>CODE + Left Cursor</b> (  )	Beginning of line
<b>CODE + Down Cursor</b> (  )	Top of next screen
<b>CODE + Up Cursor</b> (  )	Top of previous screen
<b>CODE + J</b>	Jump to page
<b>CODE + FWD→</b>	Word by word to the right
<b>CODE + BACKSPACE</b>	Word by word to the left
<b>CODE + Index</b> (  )	Advance to next text or phrase Next search word position Next stop position in forms
<b>CODE + Reverse Index</b> (  )	Advance to previous text or phrase Move to previous search word position Previous stop position in Forms Layout

---

## Correcting Errors in Memory

There are several ways to edit text typed in phrase or text memory as outlined below:

**CANCEL (  )**

Deletes one character at a time to the left of the cursor. If the cursor is located at the left margin, the **CANCEL (  )** key will position the cursor to the end of the previous line.

**QUICK ERASE**

Deletes one word at a time to the left of the cursor.

**CODE + QUICK ERASE**

Deletes the entire line to the left of the cursor

You also have the ability to delete an entire block of information typed in phrase or text memory. This feature is explained on page 83.

# Phrase Memory

The KX-E4500 will allow you to store up to 99 phrases. The length of each phrase is limited only by the available memory of your typewriter. Keep in mind however, that the phrase memory locations were designed to store small blocks of information such as names and dates, signature blocks, standard paragraphs, etc.

For example, if you were sending A&J Enterprises a multi-document package which included a cover letter, an invoice, a questionnaire, and an envelope; rather than typing their name and address on every document, you could type it once in Phrase Memory and simply print it on all of the documents.

Another example of Phrase Memory is the use of standard paragraphs. Many times you will begin or end a document with a standard paragraph. Rather than typing this paragraph each time it is required, you can store it in phrase memory and recall it when needed.

Phrase Memory is also used to store the text for headers and footers. The phrase number containing the header/footer is indicated on the print menu and automatically inserted into the document. You will learn more about headers and footers later in this manual.

Phrases are stored with no regard to margin formats. It is not possible to store margin formats in Phrase Memory. When a Phrase is recalled, it will conform to the current margin format. Below is a list of functions that can and cannot be performed in Phrase Memory.

**Phrase Memory will accept:**

**Phrase Memory will not accept:**

**Center**  
**Bold**  
**Underscore**  
**Index**  
**Reverse Index**  
**Soft Hyphen**  
**Permanent Space**  
**Permanent Backspace**

**Insert Code**  
**Tab**  
**Dec Tab**  
**X, Y, Z Margin Format**  
**Indent**  
**Line Framing**  
**Dual - Column Typing**  
**Micro Indexing**  
**Auto Paper Eject**

---

## Storing a Phrase

The phrase storage locations are accessed by pressing **CODE+Any number between 1 and 99**. If you are entering a two digit number (10 thru 99), you must hold down the **CODE** key while you enter both numbers. Enter a manual return at the end of a phrase to insure the last line of text will print.

**CODE** + (  - (  (  ) )

**1** Press **CODE + 1-99**

This will "open" the phrase.

**2** Type the desired information

**CODE** + (  - (  (  ) )

**3** Press **CODE + 1-99**

This will "close" the phrase, the information is now stored in Phrase Memory.

### Exercise

Store the following paragraph in **CODE + 1** using the Z Ruler with the MODE selector on **DISP**.

Our collection includes such interesting models as: ↵  
↵

Store the following paragraph in **CODE + 2**.

The Bennett, possible the least expensive fully keyed typewriter ever produced, sold for \$18. It could fit into a pocket and was manufactured in 1907 as "The Junior". ↵  
↵

---

Store the following paragraph in CODE + 3.

-----  
The Blickersderfer Electric was introduced about  
1902 and is the first known single-element typewriter.  
Though short-lived, this machine anticipated the  
future of typewriters by nearly 60 years.↵  
↵

Store the following paragraph in CODE + 8.

-----  
The Lambert Typewriter, dating from 1896, was a novel  
machine that had no keys. The entire top assembly  
pivoted upon the depression of a button, to swivel  
the desired character over the top of the paper below.↵  
↵

Store the following paragraph in CODE + 12.

-----  
The perfected Type Writer No. 2 appeared in 1887  
and was a Remington Standard. It was the first typewriter  
to use a Shift Key for capital letters.↵  
↵

Store the following paragraph in CODE + 99.

-----  
(Today's Date)↵  
↵

7

---

## Editing a Phrase

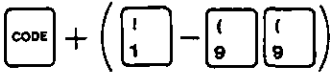

- 1 Press **CODE + 1-99** to recall the desired phrase
- 2 Position the cursor at the point of modification by using the cursor keys
- 3 Make your revisions

You can use the following keys:

**CANCEL** (  ) to delete one character at a time

**QUICK ERASE** to delete one word at a time

**CODE+**

**QUICK ERASE** to delete to the beginning of the line

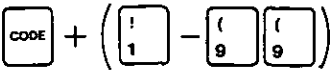

- 4 Press **CODE + 1-99** to close the phrase

## Printing a Phrase

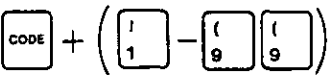

- 1 Press **CODE + 1-99** to recall the desired phrase

The screen will display the phrase.

- 2 Press **PRINT**

The phrase will print within the current margin format. You will no longer be in the phrase memory when the printing is complete.



## Clearing a Phrase

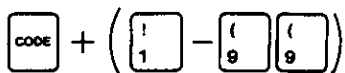

1 Open a Phrase (Press **CODE** + 1-99)

The phrase will appear on your display screen.

2 Press **EXPR**

This will move the cursor to the beginning of the phrase.

3 Press **CANCEL** (  )

The display screen will prompt:

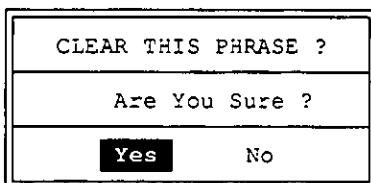

4 Press **Y** (for Yes) to confirm the cancellation

or

Press **N** (for No) to exit

## Listing Phrases

Panasonic gives you the ability to display or print a list of all the phrases you have stored. This list will indicate the phrase number, the first 20 characters on display/45 characters on printing of the phrase, the number of characters the phrase contains, and the amount of internal memory available. When printing a list, manual returns will appear as “/.” Print attributes such as bold or underline will be ignored in the phrase listing.

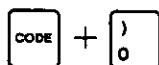

1 Press **CODE** + 0 (zero)

Your screen will prompt:

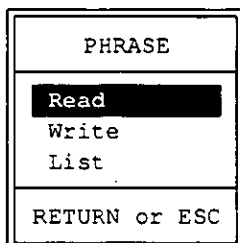



**L**

2 Press **L** (for List)

Your screen will prompt:

```
LIST
Display
Print
RETURN or ESC
```

**P**  
PAGE END

OF

**D**  
DEFAULT

QUICK  
ERASE  
ESC

3 Press **P** to print the list of phrases

or

Press **D** to display the list of phrases

Press **ESC** to clear the phrase list from the screen

Below is an example of a phrase directory:

List of Phrase		6 Files	1564	Characters Free
01	Our collection inclu	53	02	The Bennett, possibl 169
03	The Blickersderfer E	197	08	The Lambert Typewrit 212
12	The perfected Type W	149	99	(Today's Date) 16

ESC to exit

## Writing Phrases into Text Memory

The KX-E4500 gives you the ability to write all phrases 1-99 into a text memory. All phrases are read at one time, using the Write selection under **CODE + 0**. Once the phrases are written to a text memory, the text memory containing the phrases can be stored to disk.

However, the text memory containing the phrases cannot be accessed. For this reason, the text name containing the phrases will not be displayed on the edit menu. The text file containing the phrases will be displayed on the list menu with an exclamation point (!) before the text name.



- 1 Press **CODE + 0**

Your screen will prompt:

PHRASE
<b>Read</b>
Write
List
RETURN or ESC



- 2 Press **W** (for Write)

Your screen will prompt:

WRITE
Text Name [!■ ]
RETURN/RELOC to Enter or ESC

Type a text name

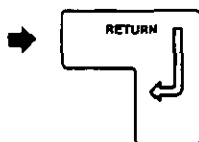

- 3 Type a new text name and press **RETURN**

The typewriter will "beep" once when the write is complete.

## Reading Phrases from Text Memory into Phrase Locations

The KX-E4500 also gives you the ability to read a text containing phrases back into their original phrase locations, or you can select the phrases to be read.

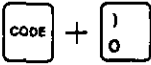

### 1 Press **CODE** + **0**

Your screen will prompt:

PHRASE
<b>Read</b>
Write
List
RETURN or ESC



### 2 Press **R** (for Read)

Your screen will prompt:

READ
Text Name [!■ ]
RETURN - Enter/List, RELOC - Enter All or ESC

Type the text name

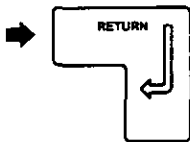

### 3 Type the text name and press **RETURN**

or

Press **RETURN** to display the directory  
(Only text files containing phrases will be displayed.)

Highlight the text name desired and press **RETURN**

- If phrases are currently stored in the phrase memory, your screen will prompt:

REPLACE
<b>All</b> Partial

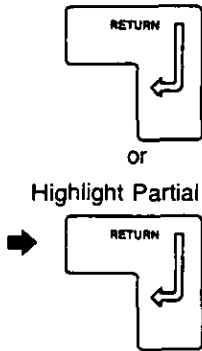

4 Press **RETURN** to select all  
or  
Highlight Partial and press **RETURN**

Your screen will prompt:

REPLACE PHRASE [XX] ?	
Are You Sure ?	
<b>Yes</b>	No

Press **Y** to replace the phrase number displayed  
or  
Press **N** to skip this phrase

## Phrase Link

Phrase Link enables you to quickly recall several phrases to print as one document. It is not necessary to wait for one phrase to finish printing before pressing the **PRINT** key to begin printing the second phrase.

If your MODE selector is on **NORM** or **DISP**, your phrases will print with a ragged right margin. If you set your MODE selector on **JSTFY**, your phrases will print with a justified right margin.

### Linking Phrases

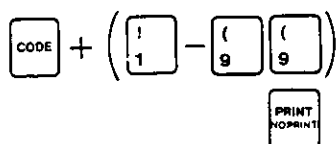

- 1 Insert a sheet of paper
- 2 Recall a Phrase (**CODE + 1-99**)
- 3 Press **PRINT**
- 4 Repeat steps 2 and 3 to recall each Phrase

### Exercise

- 1 Set your MODE selector on **JSTFY**
- 2 Recall margin format **Z**
- 3 Link phrase numbers 3, 12, 8, and 2

The Blickersderfer Electric was introduced about 1902 and is the first known single-element typewriter. Though short-lived, this machine anticipated the future of typewriters by nearly 60 years.

The perfected Type Writer No. 2 appeared in 1887 and was a Remington Standard. It was the first typewriter to use a Shift Key for capital letters.

The Lambert Typewriter, dating from 1896, was a novel machine that had no keys. The entire top assembly pivoted upon the depression of a button, to swivel the desired character over the top of the paper below.

The Bennett, possibly the least expensive fully keyed typewriter ever produced, sold for \$18. It could fit into a pocket and was manufactured in 1907 as "The Junior".

## Addressing Envelopes with Phrases

Envelopes can be printed easily using names and addresses stored in Phrase Memory. Phrases conform to the current typewriter settings; therefore, there are two points to consider—the auto insertion point and the left margin or indent position.

### 1 Set the Insertion Point

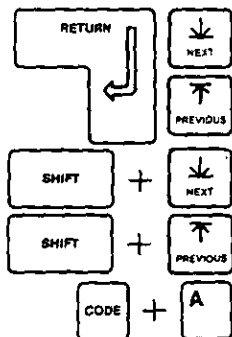

- Insert a blank envelope
- **RETURN**, **INDEX** ( $\downarrow$ ), **REVERSE INDEX** ( $\uparrow$ ), **SHIFT + INDEX** ( $\downarrow$ ), or **SHIFT + REVERSE INDEX** ( $\uparrow$ ) to reach the desired first line of print for the address
- Press **CODE + A**

### 2 Set an Indent

Rather than moving your left margin, you can set an indent. The indent will set a temporary left margin and ensure that each address prints at the same position on every envelope.

- **SPACE** or **TAB** until you reach the desired printing position
- Press  $\uparrow$ **IND**

### 3 Print the Envelopes

- Auto Insert a blank envelope
- Press **CODE + 1-99** (whichever is applicable)
- Press **PRINT**

Insert the next envelope and repeat the last two bulleted items outlined in step #3.

- 4 Press  $\uparrow$ **IND** to deactivate the indent command after all the envelopes have been addressed

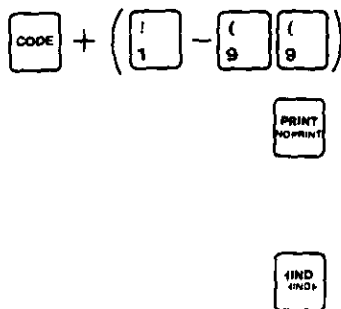

## Text Memory

Text memory is used to store lengthy documents. All the applications available on the KX-E4500 are designed for use with files stored in text memory. Text files are named by you and there is no limit to the number of files you can store in text memory. Your only limitation is the amount of internal memory available.

Only text files can be stored to disk. Later in this manual you will learn how to store phrase memory to a text so that information in phrase memory can also be stored to disk.

The KX-E4500 has simplified text handling. All text applications can be accessed with one key—the MAIN MENU key. Below is an overview of the Main Menu.

## Main Menu Overview

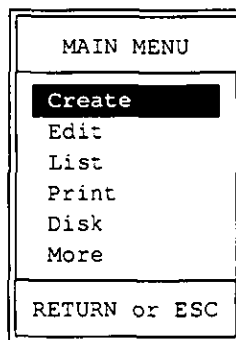

- **Create** is used when you are creating the initial text
- **Edit** is used when:
  - Recalling a text for modification
  - Recalling a text to print
  - Deleting a text from memory
  - Renaming texts
  - Scrolling through text memory
- **List** is used to display or print a list of texts that are stored in the internal memory.
- **Print** is used to command the typewriter to print a text that is stored in internal memory.
- **Disk** is used to access the disk drive
- **More** is used when:
  - Deleting text from the internal memory
  - Renaming a text

# Create

Create is used to store documents into text memory. The documents in text memory are stored by file name. The file name can be any name you choose, as long as it does not exceed ten (10) characters.

The current margin and tab settings as well as the "X", "Y", and "Z" rulers are recorded with each text you create. The KX-E4500 enables you to set your margins and tabs before accessing text memory or you can edit your margin formats while creating your document.

## Creating a Text



- 1 Press **MAIN MENU**

Your screen will prompt:

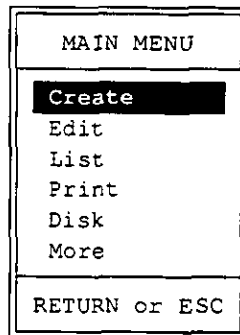

- 2 Press **C** (for Create)

Your screen will prompt:

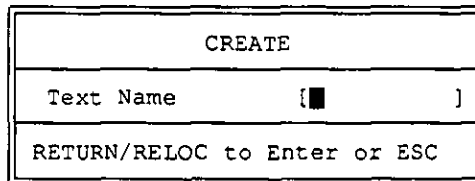

- 3 Type a text name (maximum 10 characters)

- 4 Press **RETURN**

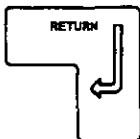

When **RETURN** is entered, the prompt on your screen will disappear. The cursor will appear in the upper left corner of the screen, and the typewriter will beep once to confirm that you are now in text memory.



---

**5** Type your document

When you have completed the document,



**6** Press **MAIN MENU**

This will close the file.

# Edit

Edit is used to recall a document stored in the text memory. The real benefits of text memory are found in the text editing features. These are the features that will simplify your typing projects and give your work a polished look.

As you become familiar with the KX-E4500, you will find that the edit mode gives you a great deal of flexibility; and, in many cases you will find that there is more than one way to perform a single task. No one way is right or wrong, it is simply a matter of comfort.

## Recalling a Text for Modification

There are two ways for you to recall a text for modification, the first way is to simply recall the text by name. The second way is to display a list of all the files stored in memory and choose your file from the directory.



### 1 Press **MAIN MENU**

Your screen will prompt:

MAIN MENU
<b>Create</b>
Edit
List
Print
Disk
More
RETURN or ESC



### 2 Press **E** (for Edit)

Your screen will prompt:

EDIT
Text Name [ ]
RETURN - Enter/List, RELOC - Enter All or ESC

Type the text name  
or

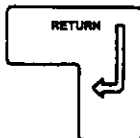

### 3 Type the text name or press **RETURN** to display the directory

If you bring up the directory, cursor to highlight the desired text.

7

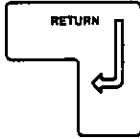

#### 4 Press **RETURN**

The text will now be displayed on your screen.

## Recalling a Ruler in Text Memory

In text memory you have the ability to recall margin and tab formats (ruler) "X", "Y", and "Z." CODE+F must be pressed at the left margin to recall a ruler in memory. If you attempt to recall a ruler when the cursor is not positioned at the left margin, the KX-E4500 will beep three times and display the message "CAN-NOT SET HERE."

#### 1 Position the cursor at the left margin

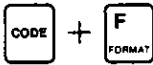

#### 2 Press **CODE + F**

Your display will prompt:

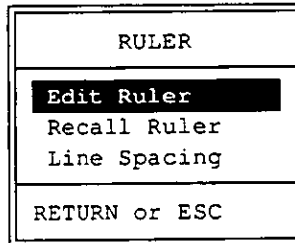

#### 3 Press the letter **R** (for Recall Ruler)

Your display will prompt:

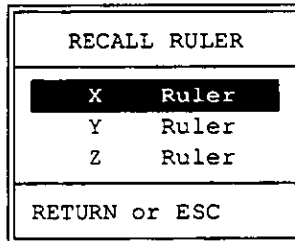

#### 4 Press the letter **X, Y, or Z**

The margin setting on the ruler line will change, and the ruler letter selected will appear at the left margin with a line over it.

## Editing a Ruler in Text Memory

When a ruler is edited in memory, all text typed under that ruler is automatically reformatted to the new settings. It is not possible to store a new ruler setting while in memory.

The Edit Ruler procedure is the same in typewriter or memory mode. Therefore, the **FWD→** key is used to move the printhead to the right and the **BACKSPACE** key is used to move the printhead to the left. Remember, it is not necessary to clear the current left and right margin or hot zone before setting new ones. The new settings will automatically clear the old settings. However, unwanted tabs must be cleared by positioning the cursor on the unwanted tab (represented by the letter "T") and pressing **TAB CLR**.

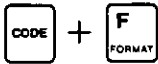

- 1 Press **CODE + F**

Your display will prompt:

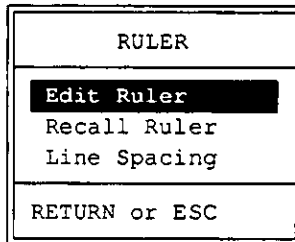

- 2 Press **E** (for Edit Ruler)

Your display will prompt:

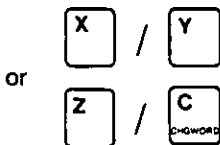
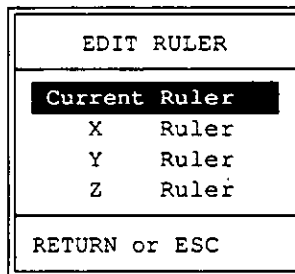

- 3 Press **X, Y, Z, or C** (for Current Ruler)

Your cursor will be positioned at 0 on the ruler line.

- 4 Make the desired changes

- 5 Press **RETURN** to enter

Text typed after the ruler change will automatically reformat.

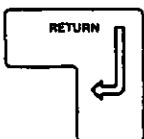

---

## Changing Line Spacing within a Text

The line spacing selector on the keyboard controls the line spacing of your text during print out. Your text will always conform to the keyboard setting unless you have a line spacing command set within the document.

Let's assume that you are creating a text in memory and your line space selector is set on single spacing. Your project requires one paragraph to be double spaced. Before typing that particular paragraph, use the line space command to change the setting to double space. This tells the system to override the selector setting on the keyboard. When you have finished typing the paragraph, insert another line space command to change the spacing back to single space.

The line spacing command must be entered when the cursor is positioned at the left margin. If you attempt to change the line spacing when the cursor is not positioned at the left margin, the KX-E4500 will beep three times and display the message "CAN-NOT SET HERE." Also, if a margin format is recalled or dual column typing is entered, the line spacing must be changed after these commands. You may also insert a line spacing command at the beginning of the text to insure it always prints in the desired spacing.

The screen only displays text in single spacing. Therefore, a line spacing command will not change the appearance of the text on your display. However, when you print the document, the selected line spacing will be honored.

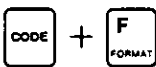

### 1 Press **CODE + F**

Your screen will prompt:

RULER	
<b>Edit Ruler</b>	
Recall Ruler	
Line Spacing	
RETURN or ESC	



### 2 Press **L** (for Line Spacing)

Your screen will prompt:

LINE SPACING			
<u>1</u>	1.5	2	3
RETURN/RELOC to Enter or ESC			

**3** Highlight the desired line spacing

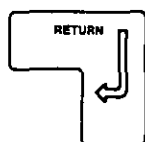

**4** Press **RETURN**

The change will be stored in the text and the line spacing symbol (  $\bar{1}$ ,  $\bar{1s}$ ,  $\bar{2}$ ,  $\bar{3}$  ) will be displayed.

## Hyphenation Scan

A hyphenation scan insures the proper appearance of your text. It locates each word that can be hyphenated. You must decide the proper hyphenation position and insert a soft hyphen (**CODE + -**). The characters to the left of the cursor as well as the soft hyphen will automatically move to the end of the previous line when scanning in the JSTFY mode.

A soft hyphen will only print if it falls within the hot zone (between the bell and the right margin). Therefore, if the text is modified and the soft hyphen no longer falls within the hot zone, the hyphenated word will print without the hyphen.

7

## Scanning Text for Hyphenation Requests

**1** Recall a text

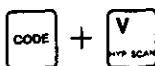

**2** Press **CODE + V**

The cursor will advance to the first word.

If the word cannot be hyphenated (e.g., proper name), skip the word by pressing **CODE + V** to advance to the next hyphen request.

**3** Backspace to position the cursor one character to the right of the desired hyphen position

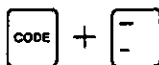

**4** Press **CODE + HYPHEN (-)**

A soft hyphen (=) will appear on your screen.

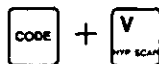

**5** Press **CODE + V** to locate the next hyphenation request

---

## Jumping to a Page

The Jump Page command enables you to quickly advance to the top of a specific page. This feature is extremely useful when working with multi-page documents.

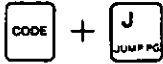

- 1 Press **CODE + J** (jump)

Your screen will prompt:

JUMP TO PAGE	
Jump to Page Number	{ }
RETURN/RELOC to Enter or ESC	

- 2 Type the page number you want to jump to
- 3 Press **RETURN**

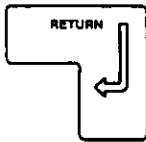

Your cursor will be positioned at the top of that page.

---

## Search

Direct Search enables you to quickly locate each occurrence of a word or string of characters without scrolling through your text.

The KX-E4500 will find all occurrences of the word or character string. It ignores print attributes such as bold or underscore and also ignores upper and lower case. Because it finds every occurrence of the character string, when searching for small words such as "the", enter a space before and after the word on the search menu so that only whole words are located. If a space is not entered, in this instance, it will also stop at words such as "theatre" and "them." If searching for long words with a unique character string, it really isn't necessary to type the entire word. For instance, if searching for a proper name such as "Cimilluca," in the search string it is fairly safe to say that if "Cimi" is entered on the search menu, the cursor will advance directly to the name "Cimilluca." If you are searching for a misspelled word, be sure to spell it incorrectly when entering the search string. In addition, the KX-E4500 also enables you to search for a manual return by entering **CODE + RETURN** in the search menu. If you enter two manual returns on the search menu you will be able to search paragraph by paragraph through your text.

When a search command is activated, the typewriter will search from the cursor position to the end of the text. For this reason, it is always best to search from the beginning of your document. The cursor positions itself to the immediate right of the word or character string entered. You can easily edit or delete the word (**QUICK ERASE**) and continue the search by pressing **CODE + INDEX** (↓). You also have the ability to search to a previous occurrence by pressing **CODE + REVERSE INDEX** (↑).



## Activating a Search

1 Recall a text from memory

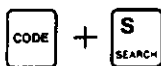

2 Press **CODE + S** (Search)

Your screen will prompt:

SEARCH STRING	
Search String	[■ ]
RETURN/RELOC to Enter or ESC	
Once the search string is located, press	
- CODE + INDEX (↓) for next location	
- CODE + REVERSE INDEX (↑) for previous location	

3 Type the word or string of characters you are looking for (maximum 30 characters)

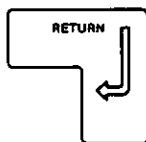

4 Press **RETURN**

Your cursor will move to the right of the first occurrence of the word or string of characters.

If the search string you are looking for is not located, your screen will prompt:

NOT LOCATED!
--------------

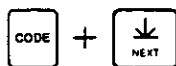

OR

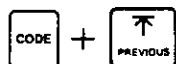

5 Press **CODE + INDEX** (↓) to advance to the next occurrence  
or

Press **CODE + REVERSE INDEX** (↑) to advance to the previous occurrence

## Global Search and Replace

Global Search and Replace is used when you have a name, date, or other word located throughout your document several times and you want it changed at all occurrences.

For example, you have a standard letter which you sent to Ms. Diana Presepe stored in text memory. You want to take that same letter and send it to Mr. Gary Karpinski; however, Diana's name is mentioned several times throughout the letter. Rather than scrolling through the document and deleting the name Diana every time it appears and inserting the name Gary, you could perform a global search and replace which would automatically exchange the name Diana with the name Gary.

### Activating a Global Search and Replace

1 Recall your text

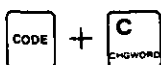

2 Press **CODE + C** (Change word)

Your screen will prompt:

REPLACE STRING	
Search String	[ ]
Replace String	[ ]
Global	Yes No
RETURN to Enter, RELOC to Enter All or ESC	

3 Type the word or words you want to replace (maximum 30 characters)

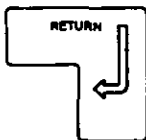

4 Press **RETURN**

5 Type the new word

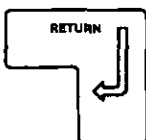

6 Press **RETURN**

The default setting "No" will be highlighted.

7 Press **LEFT ARROW** (⇐) to highlight "Yes"



7

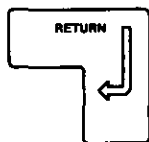

## 8 Press **RETURN**

The message "MACHINE IS BUSY" will be displayed. When the exchange is complete, the cursor will be positioned to the right of the last exchange.

## Selective Search and Replace

There may be instances when you won't want to replace a word globally. With the search and replace feature, you can choose the positions you would like the new information to be exchanged and skip the other occurrences.

### Activating a Selective Search and Replace

- 1 Follow steps 1 through 6 under "Activating a Global Search and Replace"



- 2 Press **RELOC** to confirm the "No" selection and advance to the first occurrence

Your screen will prompt:

Replace, Skip, Quit ?



or



or



- Press **R** to replace that occurrence

The system will automatically advance to the next occurrence.

- Press **S** to skip that occurrence

The system will automatically advance to the next occurrence.

- Press **Q** to quit the operation

The system will "beep" once when it has completed the selective search and replace operation.

---

## Block Move, Copy, Delete, and Print

The KX-E4500 gives you the ability to move, copy, delete or print portions of a text simply and automatically. To do this, you must first mark the area of information at the starting point and at the ending point. Once you have done this, you must indicate to the typewriter what you want to do with this information. Let's begin by learning how to mark a block of information.

### Marking a Block of Text

- 1 Recall your text
- 2 Search or Scroll to position your cursor on the first character to be marked

If you are marking indented text, place your cursor at the beginning of the line.

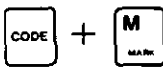

- 3 Press **CODE + M**

A mark symbol **M** will appear on the screen and the text will be highlighted from the mark symbol to the end of the document.

- 4 Search or Scroll to position your cursor on the last character to be marked

If trying to mark an entire paragraph, position the cursor to the right of both manual returns at the end of the paragraph.

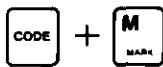

- 5 Press **CODE + M** a second time

A second mark symbol **M** will appear on the screen. The highlighting will now end at the second mark symbol.

Your text should look like this:

```
M Panasonic Communications & Systems Company is pleased to
extend our invitation for a private showing of our Antique
Typewriter Collection and our presentation of the History
of Typewriters. M
```

You may not know that Panasonic Communications & Systems Company maintains an Antique Typewriter Collection in its Executive Offices in New Jersey. We would like to invite the members of your secretarial institute to see this collection and learn more about the evolution to the typewriter.

---

Now that you have told the typewriter which block of information you want to work with, you must tell it what you would like to do with this information. Do you want to move, copy, delete or print it?

### Deleting a Block of Text

- 1 Mark the text to be deleted
- 2 Press **CODE** + **M** for a third time

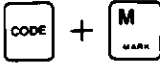

Your screen will prompt:

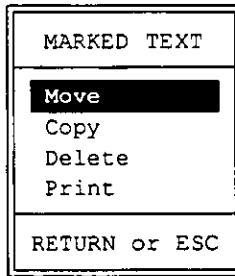

- 3 Press **D** (for Delete)

The marked text will be deleted.

### Moving a Block of Text

- 1 Mark the text to be moved
- 2 Move the cursor to the location you would like to move the text to
- 3 Press **CODE** + **M** for a third time

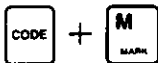

Your screen will prompt:

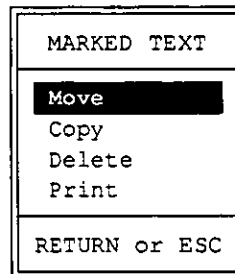

- 4 Press **M** (for Move)

The text will move to the new location and will no longer be highlighted.

---

## Copying a Block of Text

- 1 Mark the text to be copied
- 2 Move the cursor to the location you want the text copied to

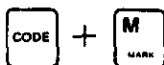

- 3 Press **CODE + M** for a third time

Your screen will prompt:

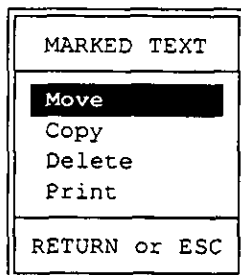

- 4 Press **C** (for Copy)

The text will appear in both the original and new location and will no longer be highlighted.

7

## Printing a Block of Text

- 1 Mark the text to be printed
- 2 Press **CODE + M** for a third time

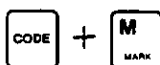

Your screen will prompt:

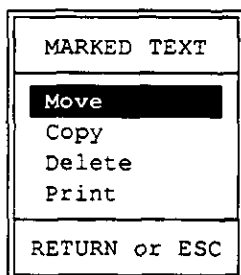

- 3 Auto insert a sheet of paper



- 4 Press **P** (for Print)

The screen will clear and display the message "PRINTING." When the printing is complete, the document will be displayed and the block of text will no longer be highlighted.

---

## Removing Marks from a Block of Text



**1** Position the cursor to the right of the first mark symbol and press **CANCEL** (  )



**2** Position the cursor to the right of the second mark symbol and press **CANCEL** (  )

**NOTE:** It is very important to delete both mark symbols. If one mark symbol is left in the document, all text from that mark symbol to the end of the document will be highlighted.

---

## Print

There are several way to print a document with the KX-E4500. You can print from within a text file or phrase location. You can also choose to print only a portion of the text file as outlined on page 84. The KX-E4500 also gives you a Print selection on the Main Menu. When you print from the Main Menu rather than from within a text, you are automatically in Background Print. Background Print enables you to print a document while simultaneously creating or editing another. In addition, the KX-E4500 also gives you the ability to print a document stored on the disk. Refer to page 214 for instructions.

The KX-E4500 enables you to define the number of printed lines per page and assign page numbering or a header and/or footer to print with your document. The following pages will explain all the print features available to you.

### Page End

A page end command enables you to tell the typewriter how many lines you want per page. The Page End command can be set while in typewriter or memory mode. You can change the setting or turn it off and on at your convenience.

The page end setting is stored with the information typed in text memory. As you type in memory, a dashed line will appear on the screen indicating where the page will end. During print out, the prompt "PAGE END !!" will appear on the screen. The printing will also stop allowing you to insert another sheet of paper and continue printing.



## Activating Page End

1 Automatically insert a sheet of paper

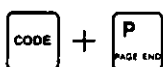

2 Press **CODE + P** (Page End)

Your screen will prompt:

PAGE END		
<b>Page End</b>	ON	<u>OFF</u>
Number of Print Line [54]		
RETURN to Enter, RELOC to Enter All or ESC		

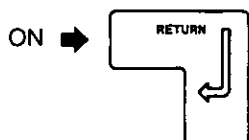

3 Highlight **ON** and press **RETURN**

The cursor will appear to the right of the "Number of Print Line."



4 Press **CANCEL** (  ) twice to erase the current page end setting

5 Type the desired number of lines (maximum 99)

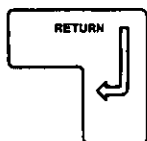

6 Press **RETURN**

## Deactivating Page End

1 Press **CODE + P**

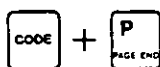

Your screen will prompt:

PAGE END		
<b>Page End</b>	<u>ON</u>	OFF
Number of Print Line [54]		
RETURN to Enter, RELOC to Enter All or ESC		

2 Highlight **OFF**



3 Press **RELOC** to enter

The page end command is deactivated.

---

## Printing with a Page End Command Activated

### Typewriter Mode

When you reach the last line of a page end setting, the keyboard will lock and the screen will prompt:

PAGE END !!

#### To Continue Typing on a New Page:

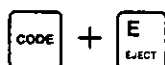

- 1 Press **CODE + E** to automatically eject the paper
- 2 Automatically insert a new sheet of paper
- 3 Continue typing

#### To Continue Typing on the Same Page:



- Press the **CANCEL** () key before typing each additional line

or

- Turn the Page End setting off

### Text Memory Mode

When the last line of a page end setting is printed, the keyboard will lock and the screen will prompt:

PAGE END !!

#### To Continue Printing on a New Page:

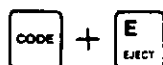

- 1 Press **CODE + E** to automatically eject the paper
- 2 Automatically insert a new sheet of paper
- 3 Press the **PRINT** key to continue



#### To Print Additional Lines on the Same Page:



- Press the **CANCEL** () key to print each additional line

---

## Printing from Within a Text or Phrase

The KX-E4500 gives you the ability to print the document you are working on while it is displayed on screen. You can print from any point within a text or phrase memory. The KX-E4500 will print from the current cursor position to the end of the text. The document is not displayed on the screen when printing. However, when the printing is complete, the document will reappear and the cursor will be positioned at the beginning of the document.

**1** Access a phrase or text memory



**2** Press **EXPR** to position the cursor at the beginning of the memory

or

Position the cursor at the point you would like printing to begin



**3** Press **PRINT**

## Halt Print

The print key enables you to print a text or phrase from within a document. It is also used to pause or quit printing. It can actually be referred to as the “start and stop” print button.

You can pause printing when an important phone call is received and resume printing at a more convenient time or you can quit printing when an incorrect phrase or text memory is recalled. When you quit printing, the phrase or text you were printing will appear on the screen and you will be in the edit mode.

## Halting a Print Command



**1** Press **PRINT** to Halt the printing

Printing will stop and your screen will prompt:

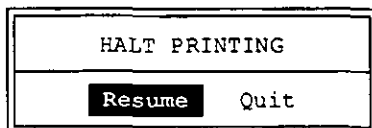

**2** Press **R** to Resume Printing

or

Press **Q** to Quit Printing

---

## Printing from the Main Menu (Background Print)

When you print from the Main Menu rather than from within a text, you are automatically in Background Print. Background Print enables you to create or edit a document while printing one or multiple documents simultaneously. Four features are listed under the Background Print menu as shown below:

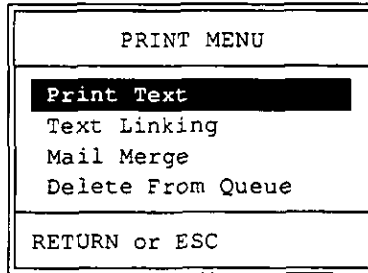

- |                          |   |
|--------------------------|---|
| <b>Print Text</b>        | Enables you select one or several (maximum eight) documents to print. You also have the ability to print multiple copies, select a header or footer to print with your text, and automatically page number. |
| <b>Text Linking</b>      | Enables you to print several documents as one. The features listed under print (e.g., page numbering) are also available under Text Linking   |
| <b>Mail Merge</b>        | Enables you to personalize correspondence by merging variable information from a mail list into a standard letter.  |
| <b>Delete From Queue</b> | Enables you to cancel the printing of files selected under Print Text.  |

## Printing a Single Text in Background Print

1 Auto Insert a sheet of paper



2 Press the **MAIN MENU** key



3 Press **P** (for Print)

Your screen will prompt:

PRINT MENU
<b>Print Text</b>
Text Linking
Mail Merge
Delete From Queue
RETURN or ESC

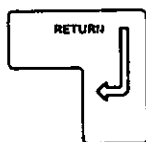

4 Press **RETURN** to select Print Text

Your screen will prompt:

PRINT TEXT			
<b>Text Name</b>	[ ]		
Copies Required	[ 1 ]		
Printed Lines Per Page	[ ]	lines	
Form Feed	[ ]	lines	
Header Phrase No.	[ ]		
Footer Phrase No.	[ ]		
Starting Page Number	[ ]		
Page No. Position	Top Right	<b>Bottom Center</b>	
Continue	Yes	No	
RETURN - Enter/List, RELOC - Enter All or ESC			

Type the text name

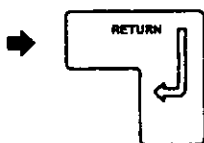

5 Type the text name to be printed and press **RETURN**

or

Press **RETURN** to display the directory

Cursor to the desired text name and press **RETURN**

The text name will be automatically inserted into the Background Print Menu.



6 Press **RELOC** to skip the other print selections and begin printing

---

## Printing Multiple Copies of the Same Text

- 1 Repeat Steps 1-5 under "Printing a Single Text in Background Print"

The cursor will be positioned to the right of Copies Required



- 2 Press **CANCEL** (  ) to delete the number 1

- 3 Enter the number of copies required



- 4 Press **RELOC** to begin printing

---

## Headers/Footers

A **HEADER** is a line or more of information that prints three lines above the insertion point or first line of print. Therefore, if your header contains more than three lines of text or you require additional blank lines between the header and the beginning of text, enter manual returns at the beginning of your text.

A **FOOTER** is a line or more of information that prints three lines below the printed lines per page setting or page end. If you require additional blank lines between the footer and the last print line, enter manual returns before typing the footer information.

In order for a Header or Footer to print within a document, they must first be stored in separate phrase locations. The phrase number containing the header or footer is then indicated on the print menu.



1 Open a phrase location (**CODE + 1-99**)

2 Type the header and footer information in separate phrase locations



3 Close the phrase (**CODE + 1-99**)

7

## Printing Text with a Header/Footer

1 Repeat steps 1-5 under "Printing a Single Text in Background Print"

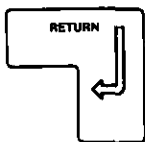

2 Press **RETURN** to position the cursor on the Header line

3 Type the phrase number containing the header text

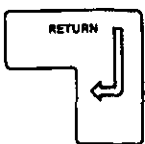

4 Press **RETURN** to position the cursor on the Footer line

5 Type the phrase number containing the footer text



6 Press **RELOC** to begin printing

---

## Page Numbering

The KX-E4500 enables you to begin page numbering with any number you choose. You also have the ability to skip the first page and begin numbering with 1 on the second page. This application is ideal when you have a title page or table of contents as the first page. In addition, you can instruct the system to print the page number at the top right or bottom center of each page. Page numbering at the bottom of the page prints three lines below the last print line. This is the same position that a footer is programmed to print. Therefore, when printing a footer in conjunction with page numbering, select the top right position for page numbering to avoid overprinting.

The page numbers are not displayed on the screen. Page numbering is activated when printing from the Main Menu only by entering a number from 0 to 9999 on the Page Number line. If no number is entered, page numbering will not be activated.

When you select Bottom Center for the page number location, it will print with a dash on either side of the number (example: - 10 -). The page number will print without dashes when Top Right is selected as the print location.

7

### Printing a Text with Page Numbers

**1** Repeat steps 1–5 under “Printing a Single Text in Background Print”



**2** **DOWN ARROW** () to the Page Number line

**3** Type the number to begin the numbering sequence

- To begin numbering the first page with 1—Enter 1  
To begin numbering the first page with 6—Enter 6, etc.
- To skip the first page and begin numbering with 1 on the second page—Enter 0



## Printing Multiple Texts in Background Print

A maximum of eight texts can be selected to print. When you select more than one file to print, you are creating a "print queue." The print features such as copies required, headers and footer as well as page numbering are individually defined for each text file selected to print.

1 Auto insert a sheet of paper



2 Press **MAIN MENU**



3 Press **P** (for Print)

Your screen will prompt:

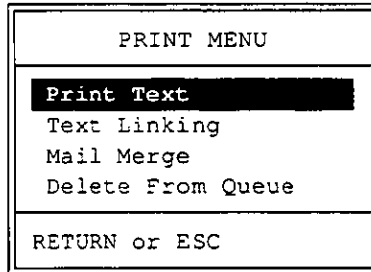

4 Press **RETURN** to select Print Text

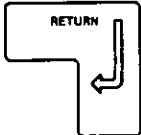

5 Press **RETURN** to display the directory

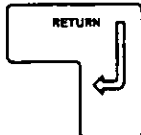

6 Cursor to the desired text name and press **RETURN**

The text name will be automatically inserted into the Background Print Menu.

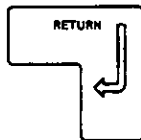

7 Complete the print menu selecting the desired print features for that text only (copies required, headers/footers, page numbering)

8 **DOWN ARROW** (⇩) to the Continue line



9 Press **LEFT ARROW** (⇐) to highlight "Yes" and press **RETURN**

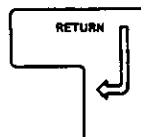

The document will begin to print and the directory will be displayed.



**10** Repeat steps 6–7 and press **RELOC** for each text file to be printed (maximum 8)

**11** Select “No” on the Continue line when no more files are required for print

## Deleting from the Print Queue

The KX-E4500 enables you to cancel the printing of any file you instruct the system to print. You can cancel the current document from printing with the **PRINT** key as discussed earlier in this manual. You can also cancel the printing of multiple texts by deleting the text name(s) from the Print Queue as outlined below.



**1** Press **MAIN MENU**



**2** Press **P** (for Print)



**3** Press **D** (for Delete From Queue)

Your screen will display the following menu with the text names you selected in the order they will print:

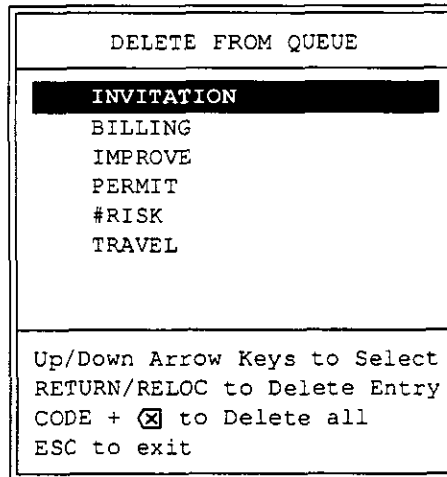

**4** Cursor to the text that you want to delete from the queue

**5** Press **RETURN** to delete the text name highlighted

or

Press **CODE + CANCEL** (  ) to delete all the names from the print queue

**6** Press **ESC** to exit

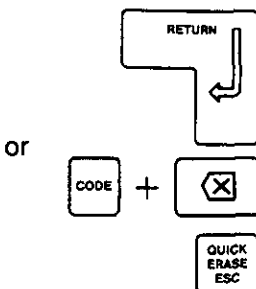

---

## Text Linking

Earlier, you learned how to append multiple documents. Text Linking is similar in concept except that the linked texts are not stored as a document in memory. They are linked for printout only, and will print as one text. This feature allows you to enter the names of each text and will print them in the order they were entered. A maximum of 8 texts may be linked at one time.

### Linking Texts

- 1 Auto insert a sheet of paper
- 2 Press **MAIN MENU**
- 3 Press **P** (for Print)



Your screen will prompt:

PRINT MENU
<b>Print Text</b>
Text Linking
Mail Merge
Delete From Queue
RETURN or ESC



#### 4 Type T (for Text Linking)

Your screen will prompt:

TEXT LINKING			
<b>Text Name</b>	[	█	]
Text Name	[		]
Text Name	{		}
Text Name	[		]
Text Name	[		]
Text Name	[		]
Text Name	[		]
Text Name	[		]
Copies Required		[	1]
Printed Lines Per Page		[54]	lines
Form Feed		[ ]	lines
Header Phrase No.		[ ]	
Footer Phrase No.		[ ]	
Starting Page Number		[ ]	
Page No. Position	Top Right	<b>Bottom Center</b>	
Width		[ ]	

RETURN - Enter/List, RELOC - Enter All or ESC

7

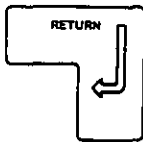

#### 5 Press RETURN with the cursor at the top on the first Text Name line to display the directory

The directory can not be displayed by pressing RETURN at any other Text Name line.

The directory will display as shown below:

List of Memory		20 Files		1234 Characters Free	
-	<b>BILLING</b> 4536	-	DATE 350	-	EXECUTOR 300
-	EXPENSES 2345	-	FAMILY 400	-	FRAME 345
-	INTENT 500	-	INVITATION 570	-	IMPROVE 287
-	LATE ACCTS 1090	-	LEGAL 7777	-	LETTER 1000
-	OVERDUE 543	-	PANASONIC 6666	-	PERMIT 7000
-	PROPERTY 5678	-	RISK 287	-	SHARES 287
-	TEXT1 333	-	TRAVEL 290		

To Select: Press Spacebar, RETURN to execute, ESC to exit

**SPACE BAR**

- 6 Highlight the first text name to print and press the **SPACE BAR** to select

The number 1 will appear next to the first file selected.

**SPACE BAR**

- 7 Highlight the next text name to print and press the **SPACE BAR** to select

The number 2 will appear next to the second file selected.

- 8 Repeat step 7 until all files to be linked have been selected (maximum 8)

If you select a file name in error or out of the desired sequence, press **ESC** and reselect the proper sequence.

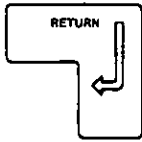

- 9 Press **RETURN** to confirm your selections and return to the Text Linking menu

The text names will be displayed on the text linking menu in the order you selected them.

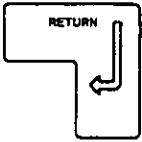

- 10 Press **RETURN** to select Copies Required

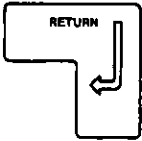

- 11 Type the number of copies required (maximum 99)

- 12 Press **RETURN** to the next line

The "Printed Lines Per Page" will display the default setting you entered on the default setting menu.

- 13 Enter the appropriate page length if needed

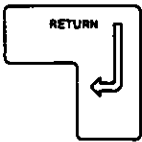

- 14 Press **RETURN** to select Form Feed

- 15 Leave blank for single sheet of paper

or

Type the number of paper length for continuous paper

---

**16** Complete Header/Footer and Page Number selections if desired.

**17** Position the cursor on the width line and enter the desired width of these documents for this print out only

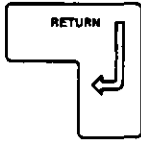

**18** Press **RETURN** to begin printing

# 8. APPLICATIONS

---

The Panasonic KX-E4500 is designed to handle a wide variety of office applications. In the pages to follow, we will be introducing you to applications that can save you countless hours of typing and retyping. Read through this section and follow the exercises. You are sure to find ways to make your workload easier.

## Centering Application for Columns

The **CENTER** key is ideal to use when determining proper tab settings to align columns of information. Below is an easy way to define proper tab positions before you begin typing a chart: This centering application is done in the typewriter mode only. Of course, the margins and tabs can be stored and recalled when typing in or out of memory.

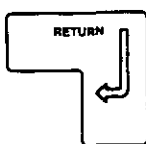
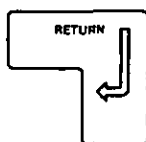
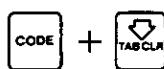

- 1 Insert a sheet of paper
- 2 At the left margin, press **CODE + TAB CLR** to clear all margins and tabs
- 3 Set your margins at the edge of the paper and press **RETURN**
- 4 At the left margin, press the **CENTER** key
- 5 Type the longest word or number in the first column
- 6 Press the **SPACE BAR** to enter the desired number of spaces between the first and second column
- 7 Repeat steps 5 and 6 for each column of information
- 8 After typing the longest word or number in the last column, press **RETURN**

The longest word in each column will print evenly spaced on the paper. If the columns appear too close together, repeat from step #4 and enter additional space between each column.

If you are unable to complete the longest word in each column, repeat from step #4 and enter fewer spaces between each column.

- 9 Space across and set margins and tabs to agree with the print out

Be sure to set a tab on the decimal point to properly align a column of numbers. Set the right margin one or two spaces after the last column.



## Example

Darlene	93 Webb Street	\$158.95	
↑	↑	↑	↑
Left	Tab	Tab	Right
Mgn	Set	Set	Mgn

## Automatic Column Layout

The KX-E4500 column layout feature automatically counts the numbers of characters and spaces needed to layout a chart in the center of a document.

A column layout must be set and stored in a margin format in typewriter mode before entering text memory. Two spaces are inserted between each column regardless of the number of columns you enter. If additional space is required between each column, press the space bar after typing the longest word in each column.

### Setting a Column Layout

1 Set your required margins

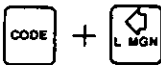

2 Press **CODE + L.MGN**

The word COLUMN LAYOUT will appear on the status line as well as the bottom of the screen. All tab settings will automatically be cleared.



3 Press **TAB** if you are entering text

or

Press **DEC TAB** if you are entering numbers

The tab will automatically be set at the decimal point position.

4 Type the longest word or number in the column

5 Repeat steps 3 and 4 for each column

6 Press **RETURN**

All tabs are now set in the proper position

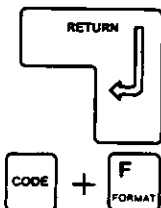

7 Press **CODE + F** to store the column layout in X, Y or Z

**NOTE:** If the column layout is wider than the margins, your screen will prompt:

RIGHT MARGIN OVER

To fit all the information on to the page, either repeat the above steps using a 12 or 15 pitch daisy wheel, or set wider margins and repeat the above steps.

If you try to set more than 28 tab stops, your screen will prompt:

TOO MANY TAB STOPS

### Column Layout Exercise

- 1 Set your left margin at 15 and your right margin at 74
- 2 Store this margin format in ruler Z
- 3 Create a new text and name it **EXPENSES**
- 4 Recall Ruler X for the body of the text
- 5 Set your MODE selector on **JSTFY**
- 6 Recall Ruler Z to type the columns
- 7 Print the text and close the file when you finished

Recall Ruler X

To: Mr. Lyndon Astorrbilt  
Marketing Services

From: Accounting Department

Date: October 15, 1988

Subject: Departmental Expenses

Per your request, please find listed below, an itemization of your department's expenses for the first three quarters of this fiscal year.

<u>TAB</u> → <u>Recall Ruler Z</u> ITEM	<u>DEC TAB</u> 1st Qtr.90	<u>DEC TAB</u> 2nd Qtr.90	<u>DEC TAB</u> 3rd Qtr.90
Furniture	3,280.00	3,280.00	5,793.00
Equipment	35,978.00	42,752.00	22,596.00
Facilities	21,985.00	21,985.00	31,467.00
Utilities	13,067.00	13,278.00	12,345.00
Entertainment	47,781.00	21,534.00	55,112.00
Travel	60,846.00	41,235.00	71,254.00
Printing	12,857.00	20,456.00	25,963.00
Postage	2,345.00	3,459.00	5,932.00
Supplies	8,456.00	4,329.00	5,987.00
<b>Sub-Total</b>	<b>206,595.00</b>	<b>172,308.00</b>	<b>236,449.00</b>
			<b>615,352.00</b>

→ Recall Ruler X

If you have any questions regarding this information, please feel free to contact us.

# Insert Codes

Insert Codes are an easy way to personalize a standard letter. Your typewriter will allow you to enter stop points into the body of a document, these stop points instruct the typewriter to stop printing so that you can insert variable information. The KX-E4500 enables you to assign prompts to each insert code. These prompts will be displayed when the document is printing.

There are no restrictions to the length of the variable information entered at each insert code. When an insert code is reached, the variable information may be manually typed or recalled from phrase memory.

## Creating a Text with Insert Codes



1 Press **MAIN MENU** and select **C** (for Create)

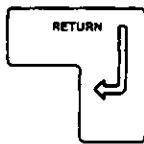

2 Name your text and press **RETURN**

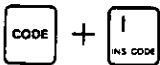

3 Begin typing the document

4 Press **CODE + I** at the Insert Code position

Your screen will prompt:

INSERT CODE	
Prompt	[ ■ ]
Enter message you want to see when printing RETURN/RELOC to Enter or ESC	

5 Type the desired prompt (maximum 30 characters)

If a prompt is not assigned, the display will show "INSERT" when the text is being printed.

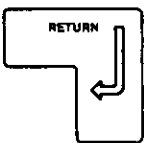

6 Press **RETURN**

The Insert Code symbol (■) will appear in your document.

7 Continue typing your text

8 Repeat steps 4, 5, and 6 for each insert position required.



9 Press **MAIN MENU** to end your text when complete

### Insert Code Exercise

- 1 Set your Mode Selector on **DISP**
- 2 Recall Margin format "X"
- 3 Store the following letter in memory under the name **BILLING**
- 4 When you reach each Insert Code position, assign the following prompts:

(Today's Date)

↑  
↑  
↑  
↑

□ ←

Dear □ : ←

←

A shipment of our paper products was sent to your office on □. Enclosed with that shipment was an invoice addressed to your attention (Invoice No. □). ←

←

Our standard terms are 2/10, Net 30. We would appreciate payment of this invoice at your earliest convenience. ←

←

We hope you are completely satisfied with our paper products. If we can be of any assistance in filling your future paper products needs, please contact us. ←

←

Sincerely, ←

←

←

←

Marion Cole ←

Vice President, Finance ←

Cole Paper Mills ←

←

MC/mh ←

## Printing a Text with Insert Codes

A text containing insert codes cannot be printed from the main print menu. Therefore, you must recall the text first and press **PRINT**.

Your text will print according to the selection of your **MODE** selector. If the **MODE** selector is set on **NORM**, the text will print up to the point that the Insert Code was set. If the **MODE** selector is positioned on **DISP** or **JSTFY**, printing will stop at the beginning of the line containing the Insert Code. At that point, you may manually type the variable information or recall it from phrase memory. Once the variable information is inserted, you simply press the **PRINT** key to resume printing.

1 Recall your text



2 Press **PRINT**

The text will print to the first Insert Code and your screen will prompt you. If you did not assign a prompt to the location, the screen will prompt:



3 Type the variable information or recall it from phrase memory

To recall a phrase:

- Press **CODE + 1-99** at the stop location



Your screen will prompt:

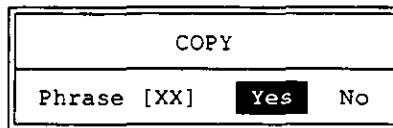

- Press **Y** (for Yes)



4 Press **PRINT** to continue



5 Repeat steps 3 and 4 for each Insert Code

# Inserting a Manual Page Break in Text Memory

You can enter a page break anywhere within text memory. The coded function, **CODE + E** is used in memory to force a page break and eject the paper during print out. After a manual page break, you must instruct the system to pause printing so that you can insert another sheet of paper. Therefore, **CODE + I** is used in this instance to pause the printer rather than insert text. **CODE + I** must be entered immediately following a **CODE+E** command. When the system sees the **CODE + I** the printing will pause so that you can insert a new sheet of paper and press **PRINT** to continue.

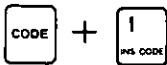
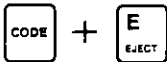

- 1 Press **CODE + E**
- 2 Press **CODE + I**

The screen will prompt:

INSERT CODE	
Prompt	[■ ]
Enter message you want to see when printing RETURN/RELOC to Enter or ESC	

- 3 Type the prompt "Insert Paper—Press PRINT"
- 4 Continue typing you text

## Inserting a Phrase into Text

You have the ability to take information that is stored in phrase memory and “copy” it into a document that you are creating or modifying in text memory. This will eliminate repetitive typing and allow you to create text quickly.

When you insert a phrase into a text, you are making a copy of that phrase. The original phrase will remain in phrase memory.

- 1 Create or recall a text
- 2 Position the cursor where you would like the phrase to be inserted
- 3 Open a Phrase (**CODE + 1–99**)

+ (  -   )

Your screen will prompt:

COPY		
Phrase [XX]	<input checked="" type="button" value="Yes"/>	<input type="button" value="No"/>

- 4 Press **Y** (for Yes)

The phrase will be inserted at the cursor position and conform to the margin format within the text.

- If you have chosen an incorrect phrase,

Press **N** (for No)

Your prompt will disappear and no change will be made to the text.

- If the phrase number entered does not contain any information, your screen will prompt:

CANNOT COPY
-------------

Try again using the correct phrase number.

# Append

Appending a document may sound terribly intimidating, but the word "append" simply means "to add to" or "to attach to." The KX-E4500 enables you to append all text files regardless of their storage location (internal memory or disk). Once you define where the text is located, you can instruct the system to insert it into another text file or phrase location. This versatility is extremely beneficial when assembling documents.

## Appending an Entire Text

- 1 Access the text file or phrase location you want to add to

You may do one of the following:

- Recall an existing text or phrase  
or
- Create a new text or phrase

- 2 Position the cursor at the desired insertion point

- 3 Press **CODE + A** (for Append)

Your screen will prompt:

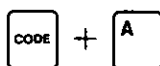

APPEND		
<b>From</b>	<b>Memory</b>	Disk
Text Name	[	]
RETURN - Enter/List, RELOC - Enter All or ESC		

- 4 Highlight the location of the text to be added (Memory or Disk) and press **RETURN**

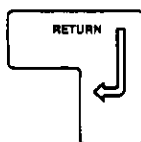

Type the text name

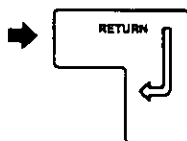

- 5 Type the name of the text to be appended (copied) and press **RETURN**

A copy of the entire text will be added to the document or phrase you accessed in step number 1. Your cursor will be positioned at the end of the appended text.



## Appending a Block of Text

The KX-E4500 also gives you the ability to append (copy) a portion of a text file stored in the internal memory into another text file or phrase location. It is not possible to append a portion of a text stored on disk.

To append a portion of the text, it must first be marked so that when the append command is given, the system will copy only the marked text. This application is ideal when you want to insert a chart or specific phrase, but do not require the entire file.

The marks are not removed after the append command has been given. Therefore, the marked portion of the text may be appended or added several times.

- 1 Recall the text file containing the block of information to be appended
- 2 Mark the beginning and ending point of the information to be appended



- 3 Press **MAIN MENU** to close this text

- 4 Access the text file or phrase location you want to add the block of information to. You may do one of the following:

- Recall and existing text or phrase
- or
- Create a new text or phrase

- 5 Position the cursor at the desired insertion point

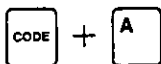

- 6 Press **CODE + A**

Your screen will prompt:

APPEND		
<u>From</u>	<u>Memory</u>	Disk
Text Name	[	]
RETURN - Enter/List, RELOC - Enter All or ESC		

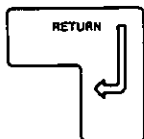

- 7 Press **RETURN** to select Memory

- 8 Type the text name containing the marked block of information

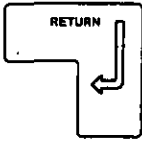

## 9 Press RETURN

The marked portion of the text is copied.

# Line Framing

Line Framing enables you to draw lines or boxes. Line framing can be done both in or out of memory. You can frame existing text, or you can frame text as you create it. The procedure used to draw boxes, horizontal and vertical lines is the same both in and out of memory. In memory you can also frame text as you type it. This operation is slightly different and separate instructions are given for this application.

## Line Framing on a Printed Page

- 1 Insert the printed page into the typewriter
- 2 Set the mode selector to **NORM**
- 3 Position printhead to top left corner of the information you want framed

This should be at least one space to the left of the text and at least 1 space above the text. If necessary, move your left margin.

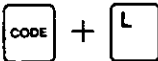

- 4 Press **CODE + L** to set the beginning point of the box

The screen will prompt:

FRAME CORNER WAS SET

- 5 Move the printer to the bottom right corner of the information to be framed.

This should be at least one space to the right of the text and at least 1 space below it.

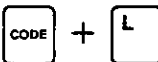

- 6 Press **CODE + L** again to set the ending point of the box

The screen will prompt:

PRINTING

The printer will move to the beginning point of the box and begin printing the lines. When the frame is complete, the printer will return to the top left corner of the box.

**NOTE:** If you press **CODE + L** twice in the same spot, your screen will prompt:

CANNOT SET HERE

Both commands will be cancelled and you must start again.

## Line Framing Exercise

- 1 Print the text **EXPENSES**
- 2 Draw a box around the chart as shown below by marking the upper left and lower right corners.

To: Mr. Lyndon Astorrbilt  
Marketing Services

From: Accounting Department

Date: October 15, 1988

Subject: Departmental Expenses

Per your request, please find listed below, an itemization of your department's expenses for the first three quarters of this fiscal year.

ITEM	1st Qtr.90	2nd Qtr.90	3rd Qtr.90
Furniture	3,280.00	3,280.00	5,793.00
Equipment	35,978.00	42,752.00	22,596.00
Facilities	21,985.00	21,985.00	31,467.00
Utilities	13,067.00	13,278.00	12,345.00
Entertainment	47,781.00	21,534.00	55,112.00
Travel	60,846.00	41,235.00	71,254.00
Printing	12,857.00	20,456.00	25,963.00
Postage	2,345.00	3,459.00	5,932.00
Supplies	8,456.00	4,329.00	5,987.00
Sub-Total	206,595.00	172,308.00	236,449.00 615,352.00

If you have any questions regarding this information, please feel free to contact us.

---

## Drawing Vertical Lines

Vertical Lines are also drawn by defining a beginning and ending point. However, the **INDEX** ( $\downarrow$ ) or **REVERSE INDEX** ( $\uparrow$ ) keys are used to insure that you are defining a straight line rather than a box. If you are just one space to the right or left, a box will be drawn rather than a vertical line. Vertical lines can be drawn from top to bottom or bottom to top.

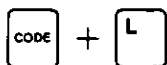

**1** Space to the position you want the vertical line to begin

**2** Press **CODE + L** to set the beginning point of the line

Your screen will prompt:

FRAME CORNER WAS SET



**3** Press **INDEX** ( $\downarrow$ ) to move to the desired end point of the line

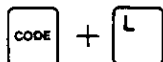

**4** Press **CODE + L** again to set the ending point of the line

Your screen will prompt:

PRINTING

The typewriter will draw the vertical line and return to the starting position.

---

## Drawing Horizontal Lines

Horizontal Lines are drawn by defining a beginning and ending point also. However, the **SPACE BAR** is used to insure that you are defining a straight line. If you return or Index even a ½ line, a box will be drawn rather than a horizontal line. Horizontal lines can only be drawn from left to right.

1 Space to the position you want the horizontal line to begin

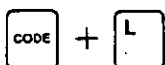

2 Press **CODE + L** to set the beginning point of the line

Your screen will prompt:

FRAME CORNER WAS SET

SPACE BAR

3 Press **SPACE BAR** to move to the desired line ending position

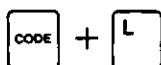

4 Press **CODE + L** again to set the ending point of the line

Your screen will prompt:

PRINTING

The typewriter will draw the horizontal line and return to the starting position.

## Horizontal & Vertical Line Exercise

Insert vertical and horizontal lines to the EXPENSES text, your finished product should look like the example below.

To: Mr. Lyndon Astorrbilt  
Marketing Services

From: Accounting Department

Date: October 15, 1988

Subject: Departmental Expenses

Per your request, please find listed below, an itemization of your department's expenses for the first three quarters of this fiscal year.

ITEM	1st Qtr.90	2nd Qtr.90	3rd Qtr.90
Furniture	3,280.00	3,280.00	5,793.00
Equipment	35,978.00	42,752.00	22,596.00
Facilities	21,985.00	21,985.00	31,467.00
Utilities	13,067.00	13,278.00	12,345.00
Entertainment	47,781.00	21,534.00	55,112.00
Travel	60,846.00	41,235.00	71,254.00
Printing	12,857.00	20,456.00	25,963.00
Postage	2,345.00	3,459.00	5,932.00
Supplies	8,456.00	4,329.00	5,987.00
Sub-Total	206,595.00	172,308.00	236,449.00 615,352.00

If you have any questions regarding this information, please feel free to contact us.

---

## Line Framing while Creating a Text in Memory

Line framing while in text memory is just as easy as line framing pre-printed documents. When you set the frame corner, be sure to return at least once and space once before typing the text. The same applies when marking the bottom right corner. Be sure to RETURN and set the frame corner at least one space to the right of the text. The text to be framed cannot be typed at the left margin. An indent must be set to indent the text, leaving enough room for the box. You will not be able to see the box or lines drawn unless you use the embed command (**CODE + =**) to display them.

- 1 Set the margins and tabs for your document
- 2 Create a new text
- 3 Return or space to the starting position of the box
- 4 Press **CODE + L**

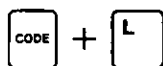

Your screen will prompt:

FRAME CORNER WAS SET

- 5 Press **RETURN**

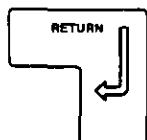

- 6 **SPACE** or **TAB** at least once



- 7 Press **←IND**

- 8 Type the text to be framed



- 9 Press **←IND** to deactivate the indentation

- 10 Press **RETURN**

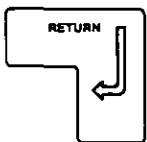

- 11 Space to the bottom right corner of the text to be framed

Make sure you are at least one space to the right of the text.

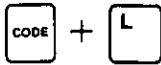

12 Press **CODE + L**

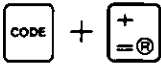

13 Press **CODE + =** to display the box

## Line Framing Exercise while Creating a Text

Using the Ruler X format, create the following text and name it **FRAME**.

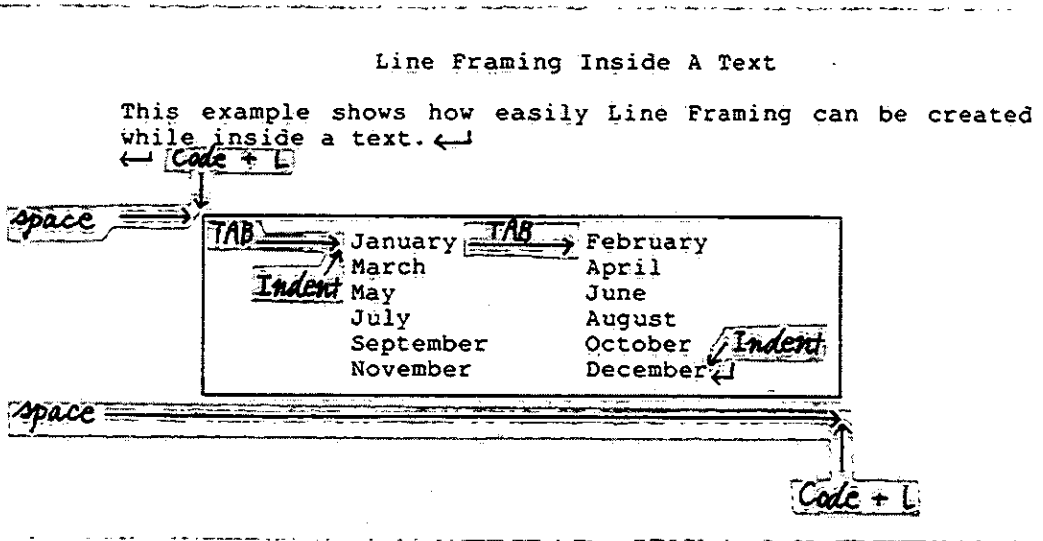

8

## Deleting a Line Frame Command within a Text

- 1 Position the cursor to the right of the line frame symbol **L**
- 2 Press **CANCEL** (  )



The line frame is automatically deleted.



# Dual Column Typing

Your typewriter gives you the ability to type dual column projects quickly and easily. This application is especially useful if you type newsletters, newspaper copy, bulletins, or any other project requiring two columns of information on a page. The typewriter enables you to set two different margin formats on one line. Both margin formats should be the same width so that the columns will look uniform. The auto paper insertion point is the first line of print in a dual column format: therefore, be sure you are at the desired insertion point before printing.

The command **CODE + W** is used for all aspects of dual column typing. It is used to set the dual column format. When typing the dual column text, **CODE + W** is used to advance from one column to the next; and when typing in memory, it is also used to access and exit the dual column typing mode.

## Setting a Dual Column Format

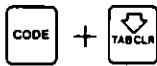

**1** Press **CODE + TAB CLR**

**2** Set the left and right margin for the first column

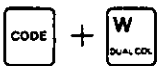

**3** Press **CODE + W**

These margins are remembered by the system. However, they will clear from the ruler and the printhead will return to 0 so the margins for the second column can be set.

**4** Set the left and right margin for the second column

Be sure to set the left margin for the second column to the right of the margins set for the first column.

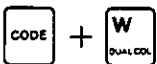

**5** Press **CODE + W**

The printhead will return to the left margin of the first column.

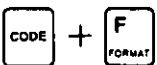

**6** Press **CODE + F** and store in ruler X, Y, or Z

The margins for the first and second column are stored as one margin format.

---

## Dual Column Margin Exercise

1 Set the following margins

Set the Left margin for column one at 7  
Set the Right Margin for column one at 37

Press **CODE + W**

Set the Left Margin for column two at 42  
Set the Right Margin for column two at 72

Press **CODE + W**

2 Store in ruler **Z**

---

## Typing a Dual Column Text in Typewriter Mode

The auto paper insertion point is the first line of print for the first and second column. When typing a dual column text, **CODE + W** advances from one column to the next positioning the printhead to the first line of print (auto insertion point).

Before typing a dual column text, a Page End setting should be set. The Page End setting is not mandatory; however, it will insure that each column is the same length.

**1** Recall the dual column format (X, Y, or Z)

Only the margins for the first column will be displayed on the ruler line.

**2** Set a Page End for the desired column length

**3** Auto insert a sheet of paper

**4** Type the first column

When the prompt "PAGE END" is displayed,

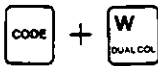

**5** Press **CODE + W** to advance to the top of the second column

**6** Type the second column

When the prompt "PAGE END" is displayed again,

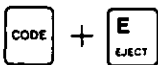

**7** Press **CODE + E** to eject the paper

**8** Press **CODE + W**

**9** Repeat steps 3-7 for each typed page required

## Dual Column Text in Memory

Typing a dual column text in memory mode differs only slightly. In the memory mode, the first time **CODE + W** is pressed you must confirm that you want to access the dual column typing mode. From that point on **CODE + W** is used to advance from one column to the next or exit the dual column mode.

The auto paper insertion point remains the first line of print for the first and second column. Therefore, the dual column text should be typed after a page break or at the beginning of a document.

A Page End setting should be set before typing a dual column text in memory. This will eliminate the need for you to enter **CODE + W** to advance from one column to the next. In the memory mode, with a page end set, the system will automatically advance to the first line of the next column when a page end is reached. Even if the next column appears on the next page. All you have to do is type.

If you type a dual column text in memory without activating a page end it will be necessary to press **CODE + W** to change columns.

When **CODE + W** is entered the first time in a text the following prompt appears so that you can access the dual column mode.

DUAL COLUMN MODE	
<input checked="" type="checkbox"/> Yes	<input type="checkbox"/> No

When **CODE + W** is entered again, the following prompt is displayed enabling you to change from one column to another. However, if you set a page end before typing a dual column text, it will not be necessary to press **CODE + W** to change columns. The system will automatically change columns for you.

DUAL COLUMN	
<input checked="" type="checkbox"/> Change	<input type="checkbox"/> Reset

The same methods used to edit normal text in memory apply when editing a dual column text. Whenever you insert, delete, or move information, the text will automatically reformat.

## Typing a Dual Column Text in Memory

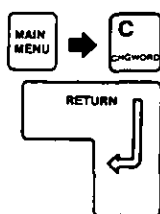

- 1 Press **MAIN MENU** and select **C** (for Create)
- 2 Name your text and press **RETURN**

- 3 Recall the dual column format (X, Y, or Z)

Only the margins for the first column will be displayed on the ruler line.

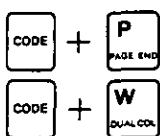

- 4 Set a Page End (**CODE + P**) for the desired column length
- 5 Press **CODE + W**

The first time **CODE + W** is entered in memory.

The screen will prompt:

DUAL COLUMN MODE	
<b>Yes</b>	No



- 6 Press **Y** (for Yes) to access the dual column typing mode

The ruler line will now display both sets of margins. The dual column text symbol (□□) will appear at the cursor position.

No is displayed on this menu to exit in case **CODE + W** was pressed in error.

- 7 Type your text

The system will automatically wrap to the beginning of the second column when the page end is reached. When the page end is reached at the end of the second column the system will automatically wrap to the first column on the next page.

**NOTE:** If you attempt to recall another margin format while in a dual column mode, the system will prompt:

CANNOT SET HERE

You must exit the dual column mode before recalling a new ruler (margin format).

If **CODE + W** is pressed when you are not within a dual column margin format, the screen will prompt:

WRONG COLUMN

### Creating a Dual Column Text Exercise

- 1 Set the typing mode selector to **JSTFY**
- 2 Create a new text and name it **LEGAL**
- 3 Recall ruler **Z**
- 4 Set a Page End for **16** lines
- 5 Type the text below

Legal offices are among the greatest beneficiaries of electronic typing and word processing. It is here that document processing has its greatest demands.

Accuracy is essential, the quantity is second to no other industry, revisions are frequent, and speed of production and editing is important.

So far as word processing is concerned, legal documents may

be separated into two groups: various legal forms (contracts, wills, trusts, etc.) that are highly standardized and briefs.

Contracts are often developed from standard paragraphs or clauses that require merge functions.

Search and replace are important functions to facilitate revisions of a previously stored document for present use.

## Editing a Dual Column Text Exercise

- 1 Recall the text LEGAL
- 2 Change the page end setting to 12 lines
- 3 Make the changes indicated below

*in this environment*  
Legal offices are among the greatest beneficiaries of electronic typing and word processing. It is here that document processing has its greatest demands.

Accuracy is essential, the quantity is second to no other industry; revisions are frequent, and speed of production and editing is important.

*extremely*  
So far as word processing is concerned, legal documents may

*add*  
A document can be produced from standard paragraphs by copying those paragraphs into a text that is unique for the project. This approach is helpful if additional writing is required to make the document flow.

*divided*  
be ~~separated~~ into two groups; various legal forms (~~contracts, wills, trusts, etc.~~) that are highly standardized and briefs.

*legal*  
Contracts are often developed from standard paragraphs or clauses that require merge functions. *or append*

Search and replace are important functions to facilitate revisions of a previously stored document for present use.

## Exiting a Dual Column Format in Memory

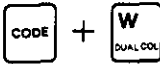

- 1 Press **CODE + W**

The screen will prompt:

DUAL COLUMN	
<b>Change</b>	Reset



- 2 Press **R** (for Reset)

You will exit the dual column typing mode.

You will only be able to type within the margins of the first column. Therefore, it will be necessary to recall a new margin format.

## Printing a Dual Column Text

- 1 Auto insert a sheet of paper

Confirm the auto insertion point for the first line of print. If necessary, set a new insertion point (**CODE + A**).

- 2 Recall the dual column text

- 3 Activate Page End

- Press **CODE + P**

The screen will prompt:

PAGE END		
<b>Page End</b>	ON	<u>OFF</u>
Number of Print Line [54]		
RETURN to Enter, RELOC to Enter All or ESC		

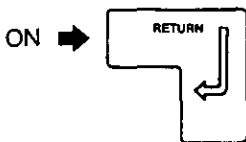

- Highlight **ON** and press **RETURN**



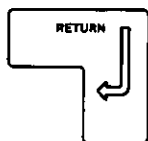

- Press **RETURN** to confirm the number of print lines

4 Press **EXPR** to position the cursor at the beginning of the document.

5 Press **PRINT**

The typewriter will type the first column and roll back to the insertion point and print the second column. When both columns are printed, the screen will prompt:

PAGE END !!

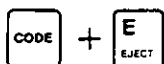

6 Press **CODE + E** to eject the paper

7 Auto insert a new sheet of paper



8 Press **PRINT** to continue

The printhead will automatically move to the left margin of the first column and continue printing.

## Mail Merge

Mail Merge allows you to merge a form letter requiring variable information with a mail list. The form letter and mail list are stored in separate text locations.

They are merged together during print out enabling you to create a personalized letter for each person on your mail list with the respective variable information inserted automatically.

The KX-E4500 also enables you to selectively print from your mail list. This is done by entering a qualifying line before each address block. This qualifying line allows you to selectively merge names and addresses that fall within a specific category.

Mail Merge can also be instructed to print only the address from the mail list allowing you to quickly address envelopes or labels.

If the mail list name is not found in the internal memory, the system will automatically search the disk and merge from there. This enables you to save internal memory for other projects by keeping lengthy mail lists on the disk rather than in the internal memory.

### Form Letter

The form letter containing the constant information is entered into text memory as normal text. Reference Codes (**CODE + R**) are inserted into the letter where the variable information in the mail list is to be inserted. Regardless of the number of lines the variable information contains (e.g., address), only one reference code is required. When you enter a reference code in the body of the letter, be sure to enter a space before and after the code. This insures that when the variable information is inserted, it will not run into the other text.

## Creating a Form Letter

Variable information is inserted into a standard letter in the order it was entered into the mail list. Therefore, the first reference code in your letter should be a name and address. This way, the mail list can be used to print envelopes and labels.

- 1 Set the desired margins and tabs
- 2 Create a new text
- 3 Begin typing
- 4 Press **CODE + R** to insert a reference code at each point variable information is required

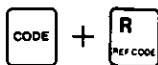

Your screen will show an ( $\bar{R}$ ) with an overscore. This instructs the system to refer to the mail list for variable information.

### Form Letter Exercise

- 1 Set your MODE selector to **JSTFY**
- 2 Set your left margin at **10**
- 3 Set your right margin at **70**
- 4 Store in margin format "**Y**"
- 5 Type the following form letter into Text Memory and name it **OVERDUE**. Be sure to enter **CODE + R** for each reference point shown below:

```
(Today's Date)←  
←  
←  
←  
R←  
←  
Dear  $\bar{R}$ :←  
←  
A copy of Invoice No.  $\bar{R}$  was sent to your office on  $\bar{R}$ . This  
invoice was issued for the shipment of  $\bar{R}$ , which was ordered  
from us.←  
←  
Your balance is now  $\bar{R}$  days past due and we would appreciate  
your payment within the next 15 days. If your check of  $\bar{R}$   
has been sent, please accept our thanks and disregard this  
notice:←  
←  
Sincerely,←  
←  
←  
←  
Lee Hayes←  
Hayes Office Equipment←  
←  
LH/m←
```

---

## Mail List

The mail list is created under a separate text name and contains all variable information necessary to merge into the form letter. The variable information is inserted in the order it is typed in the mail list. Therefore, type the name and address variable first so the mail list can also be used to address envelopes and labels.

Each variable in the mail list is enclosed in square brackets [ ], not parenthesis ( ). If you accidentally enter parenthesis or do not enter a closing square bracket, the system will not merge.

Manual returns entered within the square brackets are inserted into the form letter and will return at that point. Manual returns entered outside the square brackets will not affect the print out of the form letter. They simply separate each variable and make it easier to read the mail list if printed out.

Each group of variable information (e.g., name and address, account number, etc.) is called a record. Each record is separated by **CODE + / (SLASH)**.

Below is an example of the same mail list with and without returns entered between each variable.

## Example of a Mail list with returns after each variable

7 ↵  
[Mrs. Monica Simpson ↵  
289 Hicks Street ↵  
New York, NY 10004] ↵  
[Mrs. Simpson] ↵  
[B1343] ↵  
[12/12/86] ↵  
[5½ inch disks] ↵  
[60] ↵  
[\$325.80] ↵

7 ↵  
[Mrs. Alicia Prichett ↵  
131 Ascan Avenue ↵  
Summit, NJ 07901] ↵  
[Mrs. Prichett] ↵  
[B0984] ↵  
[1/12/86] ↵  
[marking pens] ↵  
[30] ↵  
[\$197.65] ↵

7 ↵  
[Mr. Paul Smith ↵  
1985 Harrison Road ↵  
Ridgefield Park, NJ 07660] ↵  
[Mr. Smith] ↵  
[B2589] ↵  
[12/22/86] ↵  
[magnetic tapes] ↵  
[60] ↵  
[\$321.25] ↵

## Example of a Mail List without returns after each variable

7 ↵  
[Mrs. Monica Simpson ↵  
289 Hicks Street ↵  
New York, NY 10004] ↵  
[Mrs. Simpson][B1343][12/12/86][5½ inch disks][60][\$325.80] ↵

7 ↵  
[Mrs. Alicia Prichett ↵  
131 Ascan Avenue ↵  
Summit, NJ 07901] ↵  
[Mrs. Prichett][B0984][1/12/86][marking pens][30][\$197.65] ↵

7 ↵  
[Mr. Paul Smith ↵  
1985 Harrison Road ↵  
Ridgefield Park, NJ 07660] ↵  
[Mr. Smith][B2589][12/22/86][magnetic tapes][60][\$321.25] ↵

---

## Creating a Mail List

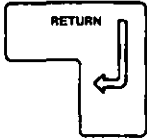
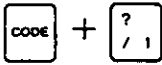

- 1 Enter Text Memory
- 2 Press **CODE + SLASH (/)**
- 3 Press **RETURN**
- 4 Type an opening square bracket [
- 5 Type the variable information
- 6 Type a closing square bracket ]
- 7 Repeat steps 4–6 for each variable
- 8 Repeat steps 2–6 for each record or group of variables

### Mail List Exercise

Open a new text and name it **LATEACCTS**. Type the mail list shown on the previous page into memory in the style you prefer. Close the text after it has been created.

---

## Merge Overview

Once the form letter and mail list is complete, you are ready to merge these texts as one document. Each letter will print with the margin and tabs set when the form letter was created. It is possible, however to change the margin width for the current print out. The Mail Merge Menu enables you to define copies required, printed lines per page, header, footer, and page numbering. The Mail Merge Menu also enables you to count the number of letters printed and define a qualifier so that you can selectively print from your mail list.

One of the most important lines of the Mail Merge Menu is Form Feed. This line instructs the system to stop after each printed letter so that you can insert a new sheet of paper or continue printing if using continuous paper.

### Printing on Individual Sheets of Paper

- Leave the line Form Feed blank.

The system will stop after each print out. You must automatically insert a new sheet of paper and press **PRINT** to continue. It's that easy.

### Printing on Continuous Paper

- Enter the total number of Form Feed lines

If you are working with letter size paper—66 lines (11"×6 lines per inch) are required.

## Merging a Form Letter and Mail List

1 Auto Insert Paper



2 Press **MAIN MENU**



3 Press **P** (for Print)



4 Type **M** (for Mail Merge)

Your screen will prompt:

MAIL MERGE			
<b>Text Name</b>	[█	]	
List Name	[	]	
Copies Required		[ 1 ]	
Printed Lines Per Page		[54] lines	
Form Feed	[	]	lines
Header Phrase No.	[	]	
Footer Phrase No.	[	]	
Starting Page Number	[	]	
Page No. Position	Top Right	<b>Bottom Center</b>	
Width	[	]	
Count Letters	Yes	<b>No</b>	
Qualifier	[	]	
RETURN - Enter/List, RELOC - Enter All or ESC			

Type the text name

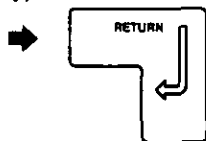

5 Type the text name of the form letter and press **RETURN**

or

Press **RETURN** to display the directory

Highlight the form letter name and press **RETURN**

The text name will be automatically inserted into the Mail Merge Menu.

Type the text name

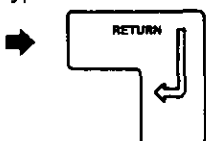

6 Type the text name of the mail list or press **RETURN** to select from the directory

“Copies Required” will be highlighted.

7 Press **RETURN** to confirm 1 copy required or enter the number of copies required and press **RETURN**

“Printed Lines Per Page” will be highlighted.



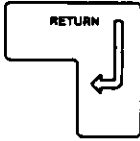
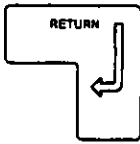

**8** Type the number of lines to print per page

**9** Press **RETURN**

"Form Feed" will be highlighted.

**10** Leave blank for single sheet paper and press **RETURN**

or

Enter the sum of the total lines per page plus the desired number of lines for the top margin on the next page for continuous paper and press **RETURN**

**11** Complete the prompt lines Header, Footer, Page Number, and Width if desired

or

Press **RELOC** to skip the remaining prompts and begin the merge.

Count Letters and Qualifier will be covered later.

---

## Qualifying Line

A qualifying line immediately follows the **CODE + SLASH (/)** before each record and enables you to selectively print from your mail list. A maximum of 30 characters are available to enter categories which enable you to selectively print from your mail list (e.g. occupation, zip code, state, etc.). Each qualifying line must be consistent. The number of categories, sequence of categories, as well as the number of characters within each category must agree from record to record. Each category or item is called a qualifier.

Qualifiers do not have to be associated with the variables in the mail list. If you want to select individuals by zip code, enter the zip code on the qualifying line. If you want to select by state, that too is entered on the qualifying line. The group of characters representing one category is called a field. The state and zip code would represent two fields.

### Entering a Qualifying Line

- 1 Recall the Mail List
- 2 Position the cursor to the right of the **CODE + SLASH (/)**
- 3 Type each qualifying category separated by a space
- 4 Repeat steps 2 and 3 for each record

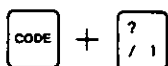

Remember, the number of categories, sequence of categories, and number of characters within each category must be the same from record to record.

### Qualifying Line Exercise

Add a qualifying line to each record in the mail list **LATEACCTS**. Use the Caps Lock feature when typing the qualifying line as shown below:

```
7NY 10004 $325 60←  
[Mrs. Monica Simpson←
```

```
7NJ 07901 $197 30←  
[Mrs. Alicia Prichett←
```

```
7NJ 07660 $312 60←  
[Mr. Paul Smith←
```

---

## Wildcards

The KX-E4500 also enables you to use wildcards to instruct the system to select any character in the field or ignore the remainder of fields on the qualifying line.

You must account for each field on the qualifying line by entering the field itself or a wildcard. If spaces are used to separate each field, they must be entered.

\* The asterisk is used to disregard the remainder of fields on the Qualifying Line.

? A question mark is used to select any character in the field allowing you to actually skip over a field.

### Example:

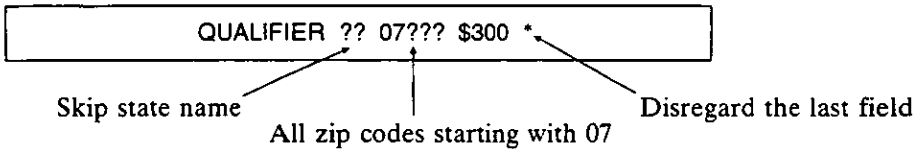

### Qualifying Mail Merge Exercises

Press **MAIN MENU**, "P", "M" and merge the form letter **OVERDUE** with the mail list **LATE ACCTS**. Remember to leave the "Form Feed" line blank when printing on single sheets of paper.

- Send a letter to all customers in NJ with a Zip Code beginning with 07.

The qualifying prompt should read:

QUALIFIER NJ 07??? \*

Two letters should print.

- Send a letter to all customers living in NY

The qualifying prompt should read:

QUALIFIER NY \*

One letter should print.

## Selectively Printing from a Qualified Mail List



Type the text name

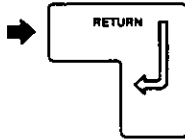

Type the text name

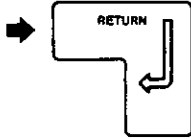

**1** Press **MAIN MENU**

**2** Press **P** (for Print)

**3** Press **M** (for Mail Merge)

**4** Enter the name of the Form Letter and press **RETURN**

**5** Enter the name of the Mail List and press **RETURN**

**6** Complete the prompt lines Copies Required, Printed Lines Per Page, Form Feed, Header, Footer, Page Number, Page No. Position, and Width.

**7** Position the cursor on the Qualifier line

**8** Type the qualifier (use Wildcards when possible)

**9** Press **RETURN**

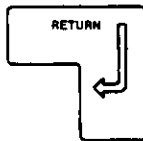

## Counting Letters to be Merged

1 Repeat steps 1-5 under "Selectively Printing from a Qualified Mail List"



2 **DOWN ARROW** (⇩) to the Count Letter line

3 **LEFT ARROW** (⇐) once to highlight Yes

4 Press **RELOC**

Your screen will prompt:

NUMBER OF LETTERS TO BE MERGED		
[XXXX] Letters		
Begin Printing	<b>Yes</b>	No

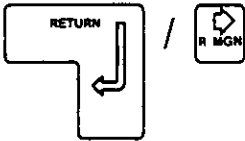

5 Press **RETURN** to begin printing

or

Press **RIGHT ARROW** (⇨) to highlight No and return to main menu.

## Using the Mail List to Print Envelopes

8

As we learned earlier, mail merge requires two components, a form letter and a mail list. When printing envelopes or labels, you must first create a text containing only a **CODE + R** and a **RETURN**. This text will act as your form letter, and instruct the typewriter to print only the first variable. Therefore, when printing envelopes, you should always enter the name and address as the first variable in the mail list.

1 Set margins for envelope



2 Press **MAIN MENU**



3 Press **C** (for Create)

4 Name the text and press **RETURN**

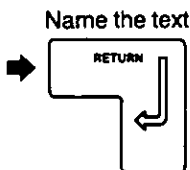

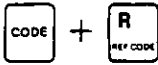

**5** Press **CODE + R**

This instructs the typewriter to insert the first variable from the mail list.

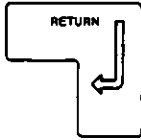

**6** Press **RETURN**



**7** Press **MAIN MENU** to close the text

**8** Auto insert an envelope

If necessary, re-set the insertion point to agree with the size of the envelope.



**9** Press **MAIN MENU**

Your screen will prompt:

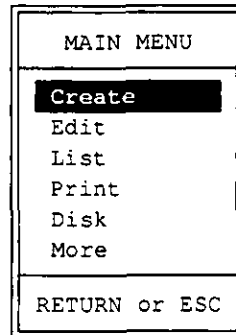

**10** Press **P** (for Print)

Your screen will prompt:

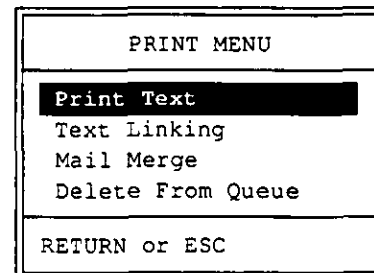

8



**11** Press **M** (for Mail Merge)

Your screen will prompt:

MAIL MERGE			
Text Name	[	]	
List Name	[	]	
Copies Required		[ 1 ]	
Printed Lines Per Page		[ 54 ]	lines
Form Feed	[	]	lines
Header Phrase No.	[	]	
Footer Phrase No.	[	]	
Starting Page Number	[	]	
Page No. Position	Top Right	<b>Bottom Center</b>	
Width	[	]	
Count Letters	Yes	<b>No</b>	
Qualifier	[	]	
RETURN - Enter/List, RELOC - Enter All or ESC			

**12** Enter the name of the text containing the **CODE + R**

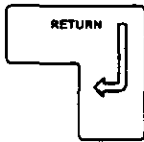

**13** Press **RETURN**

**14** Enter the name of your mail list

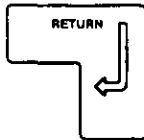

**15** Press **RETURN**



**16** Press **RELOC** to begin printing

After the first envelope has been printed, your screen will prompt:

PAGE END !!
-------------

Press **ESC** to delete the main menu (this will appear only after the first envelope)

Press **CODE + E** to auto eject the envelope, auto insert a new envelope



**17** Press **PRINT** continue with the next envelope

---

## Using the Mail List to Print Labels

(Continuous roll only)

**1** Follow steps 1 through 13 as outlined in Using the Mail List to Print Envelopes

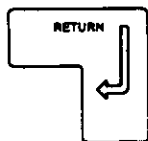

**2** After you have entered the name of your mail list, press **RETURN** until you reach the selection for Printed Lines Per Page

**3** For a 1" Label enter the number 4

This indicates that up to 4 lines can be printed on the label

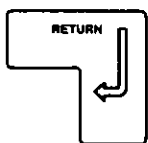

**4** **RETURN** until you come to the Form Feed selection

**5** Enter the number 6

This instructs the typewriter to return twice before printing the next label.

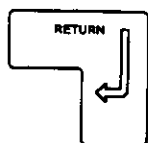

**6** Press **RETURN**



**7** Press **RELOC** to begin printing



---

## Merging a Mail List Directly from Disk

You have already learned how to perform a Mail Merge function with the mail list and form letter in the internal memory of your typewriter.

You should be aware that you may also do a Mail Merge directly from the disk. This enables you to merge a mail list stored on disk with a form letter stored in the internal memory.

You will save internal memory space for other projects and still have the complete mail list to merge and print from when necessary.

The operation is exactly the same as outlined under "Merging a Form Letter and Mail List." The only difference is that the mail list is stored on disk, not in the internal memory. The KX-E4500 automatically searches for the list name, first within the internal memory, when not found, it automatically searches on the disk for the mail list file and continues.

- 1** Store the mail list to disk
- 2** Clear the mail list from the internal memory
- 3** Follow the steps outlined under "Merging a Form Letter and Mail List"

## Forms Layout

Forms Layout allows you to fill in pre-printed forms easily and automatically. An unlimited number of forms can be stored in text memory with a maximum of 99 stops each. An asterisk is entered before the text name for easy recognition of a form in text memory. **CODE + EXPR** creates the asterisk and it must be entered before typing the text name.

When setting up the form, you can assign a prompt (30 characters) which will display when filling in the form or you can instruct the typewriter to automatically insert a phrase at a stop location. The prompts you assign will assist you when printing the form. Automatic phrase insertion allows you to store constant text which eliminates repetitive typing. If you do not assign a prompt or store constant text, the screen will simply prompt "INSERT" when that stop is reached.

When printing a form, the **PRINT** key is used to advance the printer to each programmed stop. The prompt you assigned will be displayed and you may manually enter the required text or recall it from phrase memory. If you instruct the typewriter to print a phrase, the printer will automatically advance to the next programmed stop.

An **INDENT** (temporary left margin) is automatically set at each stop; therefore, if more than one line of information is entered, it will automatically be aligned. Forms Layout will move to the exact stop position you set regardless of the number of lines entered at each stop.

When you are printing a form, the typewriter also allows you to access tabs which were set on the ruler before the form stops were entered. To do this, simply press **TAB**, or **DEC TAB** if you wish to align the numbers at the decimal point.

---

## Setting up the Form

The Forms Layout feature uses the left margin and the insertion point to remember the exact positions of each stop location. Both the left and right margin setting, along with any tabs set between them, are stored with the layout. However, the insertion point is not. If the auto insertion point is changed after the form is set up, the programmed stops will not align properly. Therefore, it is suggested that a blank form noting the original paper insertion point be saved so the insertion point can be reset.

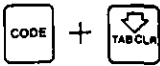

**1** Press **CODE + TAB CLR** to clear existing margins and tabs

**2** Auto insert your form

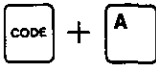

**3** Set the Auto Insertion point (**CODE + A**)

**4** Type an **X** to mark the insertion point

**5** Set the left and right margin at the edge of the form

**6** If working with an invoice form, set tabs to fill-in the variable line items (e.g. Quantity, Description, Price, etc.)

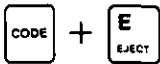

**7** Remove the form (**CODE + E**)

Save this form with the insertion position marked so it can be reset if necessary.

---

## Stop Positions

The following keys are used to advance to the desired stop positions when creating a form.

<b>SPACE BAR</b>	<b>INDEX ( ↓ )</b>
<b>BACKSPACE</b>	<b>REVERSE INDEX ( ↑ )</b>
<b>CODE + SPACE BAR</b> (Micro Space)	<b>SHIFT + INDEX ( ↓ )</b>
<b>CODE + H</b> (Half Space)	<b>SHIFT + REVERSE INDEX ( ↑ )</b>
	<b>RETURN</b>

A maximum of 99 stops can be stored in forms memory. If you try to set more, your screen will prompt:

TOO MANY STOP POINTS

Press **MAIN MENU** to clear this prompt and end the form.

If you set a stop within the hot zone (between bell and right margin), indent will be ignored when the form is printed.

## Storing Stop Positions

1 Set up the form as outlined in the previous instructions



2 Press **MAIN MENU**



3 Press **C** (for Create)

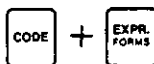

4 Press **CODE + EXPR**

An asterisk will be displayed before the text name as shown below:

CREATE	
Text Name	[ * ]
RETURN/RELOC to Enter or ESC	

5 Type the text name

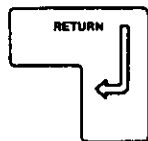

6 Press **RETURN**

7 Auto insert the form

8 Advance to the position where you would like to set the first stop position



9 Press **TAB SET**

Your screen will prompt:

STOP POSITION	
Prompt	[ ]
Enter message you want to see when printing RETURN/RELOC to Enter or ESC	

### TO ASSIGN A PROMPT:

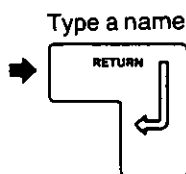

• Type a name and press **RETURN**

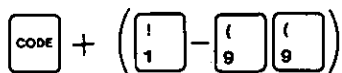

**TO AUTO INSERT A PHRASE:**

- Press **CODE + 1-99** (your choice)

Your screen will prompt:

COPY		
Phrase [XX]	Yes	No

- Press **Y** (for Yes) or **N** to clear prompt



**IF NO PROMPT IS REQUIRED:**

- Press **RETURN**

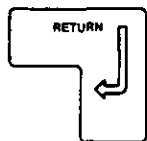

**10** Continue with the steps outlined to set the remaining steps

**11** Press **MAIN MENU** to end the form



---

## Form Fill-In

The **PRINT** key advances you to each stop position stored in the Forms Layout memory.

**DEC TAB** and **TAB** will advance you to tabs set on the writing line. **DEC TAB** will align decimal points at the tab position and whole numbers or text to the left of the tab setting. **TAB** aligns all characters to the right of the tab setting.

For example, **DEC TAB** would be used to align Quantity, Item, Unit Price or Total. **TAB** would be used to align description.

Press **RETURN** to begin each new line item when accessing tabs on the writing line. When the line items are complete, press **PRINT** to advance to the next stop stored in Forms Layout memory.

It is important to note that the Forms Layout acts as a continuous loop and will advance to the first stop position when the **PRINT** key is pressed at the last stop position. The prompt "TOP OF FORM" will be displayed when you return to the first stop position. This enables you to fill-in several forms without recalling the form layout each and every time.

If the prompt "CANNOT COPY" is displayed when filling in your form, manually type the required information and press **PRINT** to continue. When the form is complete, check to see if the phrase was deleted.

## Filling-In a Form



1 Press **MAIN MENU**



2 Press **E** (for Edit)

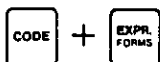

3 Press **CODE + EXPR**

Your screen will prompt:

EDIT	
Text Name	[* ]
RETURN - Enter/List, RELOC - Enter All or ESC	

4 Type the text name

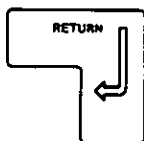

5 Press **RETURN**

6 Auto insert the form

7 Press **PRINT**



The printer will advance to the first stop and display a prompt. If a phrase was recalled while storing the stop position, the phrase will print and advance to the next stop position.

8 Type the information required

or

Press **CODE + 1-99** to recall a phrase



Your screen will prompt:

COPY	
Phrase [XX]	<input checked="" type="checkbox"/> Yes <input type="checkbox"/> No



Press **Y** (for Yes)



9 Press **PRINT** to advance to each stop positioned on the form

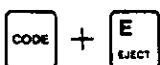

10 When the form is complete, press **CODE + E** to eject the form





## 11 Press **MAIN MENU** to exit the Form Layout

or

Auto Insert a second form and Press **PRINT** to continue from the top of the form

## Correcting Errors on a Form

### Correcting Errors at a Current Stop Position

Press **CANCEL** (  ) to delete characters to the left, or press **QUICK ERASE** to delete an entire word to the left.

If the stop position has several lines of text, you may use the same correction procedures as those outlined when making corrections within the correction memory.

### Correcting Errors at a Previous Stop Position

1 Set the MODE selector at **NORM**

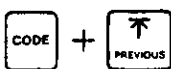

2 Press **CODE + REVERSE INDEX** (  ) to reach the stop position containing the error

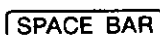

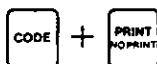

3 **SPACE** to position printer over the error(s)



4 Press the **CODE + PRINT** key to enter NO PRINT mode



5 Retype the error and press the **CANCEL** (  ) key to make your correction

**NOTE:** If the text was typed in **JSTFY**, keep the MODE selector on **JSTFY**, press **CODE + PRINT** and retype the entire line until the printer returns. Press **CANCEL** (  ) until all characters are deleted from the display and the printer advances to the end of the previous line. Make corrections as you would within the correction memory.

---

## Adding Stop Positions

- 1 Recall the form
- 2 Auto insert the form
- 3 Press the **PRINT** key until you reach the stop position closest to the one you want to insert
- 4 Move to the desired position
- 5 Press **TAB SET**



## Inserting a Stop Position to the Left of the Current Stop

An indent is automatically set at each stop. Therefore, if you want to move the printer to the left of the tab to add a new tab stop, you will have to release the Indent.

- 1 Press the **PRINT** key until you reach the stop position closest to the one you want to insert
- 2 Press **IND** to release the indent
- 3 Press **RETURN**
- 4 Move to the desired stop position
- 5 Press **TAB SET**

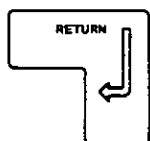

## Deleting Stop Positions

- 1 Recall the form
- 2 Auto insert the form
- 3 Press the **PRINT** key until you reach the stop position to be deleted
- 4 Press **TAB CLR**



---

## Deleting an Automatic Phrase Insertion Stop Position

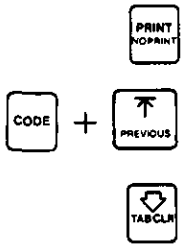

- 1 Recall the form
- 2 Auto insert the form
- 3 Press **PRINT** until you pass the stop position to be deleted
- 4 Press **CODE + REVERSE INDEX** ( ↑ ) to return to the stop position to be deleted
- 5 Press **TAB CLR** to delete the position

## Editing Prompts

To edit the prompt, the tab stop must be deleted and then reset



- 1 Delete the tab stop with the incorrect prompt (Press **TAB CLR**)
- 2 Press **TAB SET**

You can reset the tab in the same position, if desired

Your screen will prompt:

STOP POSITION	
Prompt	[ ■ ]
Enter message you want to see when printing RETURN/RELOC to Enter or ESC	

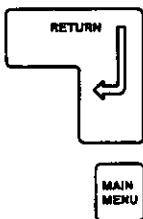

- 3 Type the new message
- 4 Press **RETURN**
- 5 Press **MAIN MENU** to exit the form

# 9. SPELLCORRECT®

---

Spellcorrect® offers a Houghton Mifflin 63,000 word base dictionary which is ROM (Read Only Memory) based. This means that the words in the dictionary cannot be edited or erased.

Along with the base dictionary, Panasonic has included a 200 word user glossary. The glossary allows you to store 200 words that will be used in conjunction with the base dictionary. Words may be added to or deleted from the glossary one at a time in the typewriter and memory modes. In addition, while in the typewriter mode you have the ability to input an entire text of words into the user glossary at one time. The glossary can also be output to a text memory so that you can store it to disk.

The SpellCorrect® operation is the same when typing in the typewriter or memory mode. When an unrecognized, misspelled or doubled word is typed, your typewriter will beep twice and the word will flash on your display. You have the ability to manually correct the word, display alternate spelling suggestions, skip the word, insert the word into the user glossary, or quit the SpellCorrect feature.

However there are a few exceptions to this rule:

- When typing in the typewriter mode with your mode selector set on NORM if an unrecognized or double word is typed, your only option is to correct the word and continue typing. Therefore, to take full advantage of the SpellCorrect® feature in typewriter mode, it is suggested that you type in the DISP or JSTFY mode.
- Only in the typewriter mode can you to input an entire text of words into the user glossary or output the glossary to a text memory. This is one reason why the SpellCorrect® menu differs when displayed in the typewriter and memory modes.
- Only in the memory mode can you Scan an existing phrase or text for spelling errors.

# SpellCorrect® Menu Overview

## Typewriter Mode

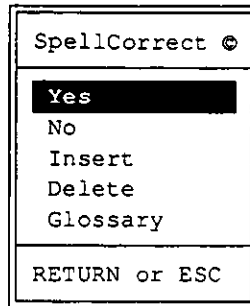

- Yes** Turns SpellCorrect® On and checks each word as it is typed.
- No** Turns SpellCorrect® Off.
- Insert** Inserts a word into the glossary.
- Delete** Deletes a word from the glossary.
- Glossary** Enables you to input words typed in text memory into the user glossary or output a glossary to text the memory. You also have the ability to list the glossary on the display, as well as print or clear it.

## Memory Mode

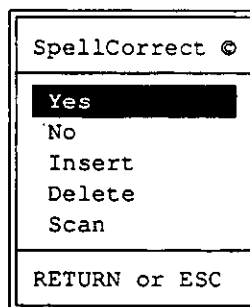

- Yes** Turns SpellCorrect® On and checks each word as it is typed.
- No** Turns SpellCorrect® Off.
- Insert** Inserts a word into the glossary.
- Delete** Deletes a word from the glossary.
- Scan** Searches through an entire document for misspelled or double words.

## Turning SpellCorrect<sup>®</sup> On



1 Press **SPELLCORRECT**

Your screen will prompt:

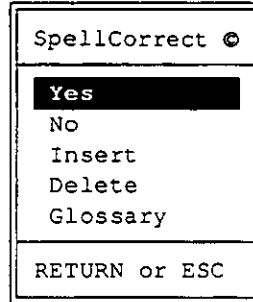

2 Press **Y** (for Yes)

Your screen will display **SPELL** on the top line.

3 Begin typing

## Turning SpellCorrect<sup>®</sup> Off



1 Press **SPELLCORRECT** when a word is not flashing on the screen

Your screen will prompt:

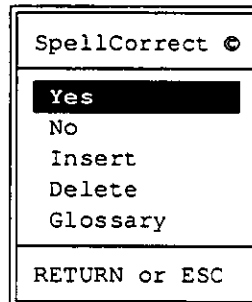

2 Press **N** (for No)

3 Continue typing

# Quit

Quit enables you to turn SpellCorrect® off when an unrecognized word is flashing.

## Quitting SpellCorrect®



- 1 Press the **SPELLCORRECT** key

Your screen will prompt:

Alternatives, Skip, Insert, Quit ?



- 2 Press **Q** (for Quit)

Your typewriter will beep once to confirm that SpellCorrect® has been deactivated.

# Making Manual Corrections

- 1 Turn SpellCorrect® On and begin typing

When an unrecognized word is typed, the system will “beep” twice and the word will flash on the display

- 2 Backspace to position the printer to the right of the error



- 3 Press **QUICK ERASE** to delete the entire word

or

Press **CANCEL** (  ) to delete one character at a time

- 4 Make the correction and continue typing

## Exercise

Type the following paragraph in the **DISP** or **JSTFY** mode. Use the steps outlined above to correct the errors. Remember, the error will flash on the display. There is no need to correct proper names; therefore, continue typing although the word will continue to flash on the display.

There will be a company meeting in the large conferance room located in the south lobbie. Mr. Penter will be arriving at the airpout at approximatly the same time as Dr. Carlton. The doctor is our guast speaker at this meeting. Please arrange for a limosine to pick them up at the airport, promptly at 5:30 o'clock.



# Alternatives

The Alternatives selection displays alternate spelling suggestions in the grey area at the bottom of the screen. When a word is selected, it is automatically inserted onto the text. When scanning a document, the system will advance to the next unrecognized word automatically.

## Displaying Alternate Spelling Suggestions

- 1 Turn SpellCorrect® on and begin typing

When an unrecognized word is typed, the system will “beep” twice and the word will flash on the display.



- 2 Press the **SPELLCORRECT** key

Your screen will prompt:

Alternatives, Skip, Insert, Quit ?



- 3 Press **A** (for Alternatives)

The system will briefly display the prompt, “MACHINE IS BUSY” while searching for spelling suggestions.

- One of the following prompts will appear to the right of the spelling suggestions:

↵ Select or ESC

Displayed when all spelling suggestion available are shown.

⏪ More, ↵ Select or ESC

Displayed when another panel of spelling suggestions is available.

⏪ More, ↵ Select or ESC

Displayed when at the last panel of spelling suggestions.

If you want to display the another panel, press **DOWN ARROW** (⏩) or **UP ARROW** (⏪).

- If the word you are looking for is not among the list of alternative spelling suggestions:

Press **ESC** to return to the SpellCorrect® menu shown in step number 2 and choose another option.

or

Press **ESC** twice to exit the SpellCorrect® menu and make a manual correction.

- If no spelling suggestions are available, the following prompt will appear:

NO ALTERNATIVES!

Press **ESC** to return to the SpellCorrect® menu shown in step number 2 and choose another option.

or

Press **ESC** twice to exit the SpellCorrect menu and make a manual correction.



- 4 Press **RIGHT ARROW** (⇨) or **LEFT ARROW** (⇧) to highlight the correct spelling

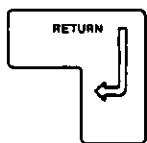

- 5 Press **RETURN** to insert the correct spelling

## Correcting a Double Word

The KX-E4500 will delete the second occurrence of a double word for you automatically.

- 1 Turn SpellCorrect® on and begin typing

When the same word is typed twice, the system will “beep” twice and both words will flash on the display.



- 2 Press the **SPELLCORRECT** key

Your screen will prompt:

Correct, Skip, Quit ?



3 Press **C** (for Correct) to delete the second word

Press **S** (for Skip) to leave both words

Press **Q** (for Quit) to turn SpellCorrect® off

4 Continue typing

## Skip

Not all words that are flagged by the system require correction, nor do they need to be inserted into the user glossary. For this reason, the KX-E4500 enables you to “skip” over a flashing word. This feature is ideal when a proper name or company name not normally typed is flagged by the system.

### Skipping a Flashing Word

1 Turn SpellCorrect® On and begin typing

When an unrecognized word is typed, the system will “beep” twice and the word will flash on the display.



2 Press the **SPELLCORRECT** key

Your screen will prompt:

Alternatives, Skip, Insert, Quit ?



3 Press **S** (for Skip)

The typewriter will “beep” once to confirm your selection and the word will stop flashing.

4 Continue typing.

## Insert

Frequently typed proper names or industry specific terms will be unrecognized by the SpellCorrect® base dictionary. Therefore, the KX-E4500 enables you to insert 200 words (maximum 30 characters each) into the user glossary to be used in conjunction with your base dictionary.

Although the base dictionary is not sensitive to upper or lower case characters, there are a few rules to keep in mind when inserting words into the user glossary. You must enter a word into the glossary in all lower case letters in order for that word to be recognized regardless of case. However, you may want SpellCorrect® to alert you when a proper name is not capitalized. In this instance, it is best to insert the word into the glossary typed in initial caps. Below is an example of how SpellCorrect® accepts upper and lower case.

<u>You Insert</u>	<u>SpellCorrect® Recognizes</u>
panasonic	panasonic, Panasonic, PANASONIC
Panasonic	Panasonic, PANASONIC
PANASONIC	PANASONIC

Words can be inserted into the user glossary one at a time with the SpellCorrect® feature on or off as well as in typewriter or memory modes. An entire text of words can be input into the glossary while in the typewriter mode only.

---

## Inserting a Word into the Glossary with SpellCorrect® On

- 1 Turn SpellCorrect® On and begin typing

When an unrecognized word is typed, the system will “beep” twice and the word will flash on the display.



- 2 Press the **SPELLCORRECT** key

Your screen will prompt:

Alternatives, Skip, Insert, Quit ?



- 3 Press **I** (for Insert)

Your typewriter will “beep” once to confirm that the word was entered into the glossary.

- If the glossary is full, your screen will prompt:

GLOSSARY FULL!

Press **ESC**

- 4 Continue typing

---

## Inserting a Word into the Glossary with SpellCorrect® Off

- 1 Type the word you would like inserted and space once
- 2 Press the **SPELLCORRECT** key



The screen will prompt:

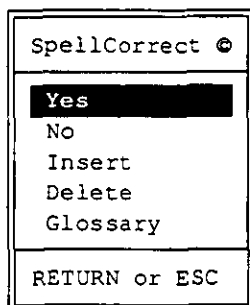

- 3 Press **I** for Insert



The typewriter will "beep" once to confirm

### Exercise

Type the following sentence in the **DISP** mode and insert the word "Cardiopathy" into the glossary as you are typing.

9

Dr. Carlton will be discussing the probable cause of cardiopathy affecting men and women 30 years of age and older.

Now insert the following medical terms into the glossary:

adenopathy, rhinopathy, angiopathy, dermatopathy

# Delete

## Deleting a Word from the Glossary

1 Position the cursor one space to the right of the word to be deleted from the glossary



2 Press the **SPELLCORRECT** key



3 Press **D** (for Delete)

- If you try to delete a word that does not exist in the glossary, your screen will prompt:

WORD NOT IN GLOSSARY!

Press **ESC** to clear the prompt

### Exercise

Delete the word “angiopathy” from the glossary. Your glossary should now contain four medical terms.

# Scan

The Scan feature searches through a phrase or text memory for unrecognized, misspelled, or double words. It will scan the text from the current cursor position to the end of the document. Therefore, it is best to position the cursor at the beginning of the document before activating a scan.

If you ESC to make a manual correction in the Scan mode, the scan will be deactivated. You must repeat steps 2 and 3 below to continue.

## Scanning a Text or Phrase Memory

1 Access a Phrase or Text Memory



2 Press the **SPELLCORRECT** key

The screen will prompt:

A rectangular dialog box with a title bar "SpellCorrect ©". Inside, there is a list of options: "Yes" (highlighted with a black background), "No", "Insert", "Delete", and "Scan". At the bottom, it says "RETURN or ESC".

```
SpellCorrect ©
Yes
No
Insert
Delete
Scan
RETURN or ESC
```

3 Press **S** (for Scan)



The cursor will advance to the right of the first unrecognized word, "beep" three times, and the word will flash on the display.

The following prompt will appear:

A rectangular box containing the text "Alternatives, Skip, Insert, Quit ?".

```
Alternatives, Skip, Insert, Quit ?
```

**Alternatives** Displays a list of alternate spelling suggestions, automatically inserts the word you select into the document and advances to the next unrecognized word.

**Skip** Cancels the flashing and advances the cursor to the next unrecognized or double word.



---

**Insert**            Inserts the flashing word into the user glossary and advances to the next unrecognized or double word.

**Quit**             Turns SpellCorrect<sup>®</sup> off when a word is flashing

**4** Type the first letter of your selection.

For a detailed explanation of Alternatives, refer to the instructions under "Displaying Alternate Spelling Suggestions."

**5** Repeat step 4 for each flashing word.

When the scan is complete the cursor will appear at the end of the document

## Exercise

With the SpellCorrect<sup>®</sup> feature turned off, create a text named **SCAN** and type the following paragraph without correcting errors. Close the text when finished.

---

Approximately 50 percent of Dr. Carlton's patients suffer from such severe gastritis for which the only corrective measure available is a gastrectomy. He feels the increase in stomach disorders is directly related to poor eating habits and unhealthy life styles.

---

To practice, recall the text **SCAN** and scan the document. Follow the instructions outlined above and correct the document as you advance to each error. Skip the proper name and when you reach the word "gastrectomy," add this word to the glossary.

# Glossary

The Glossary feature is only available when in the typewriter mode. It enables you to input an entire text into the user glossary at one time. Once the glossary is input to text memory, it can be stored to disk. You also have the ability to output the user glossary to a text memory. Storing a text file containing the glossary words to disk gives you an opportunity to clear the glossary and create another. This is ideal when several glossaries are required for specific work environments such as legal or medical. The glossary feature also enables you to display or print the words contained in the glossary.

When you input a text to the glossary, SpellCorrect® will add the words in the text memory to those currently in the glossary. If you want only the words from the text in the glossary, clear the entire glossary before reading the text. If a word you are inputting already exists in the main dictionary, it will not be added to the user glossary.

## Inputing a Text Memory into the User Glossary

- 1 Create a document in text memory containing words to be input into the user glossary

Each word must be followed by a space or a manual return to be accepted into the user glossary.



- 2 Press the **MAIN MENU** key to close the memory and return to the typewriter mode



- 3 Press the **SPELLCORRECT** key

Your screen will prompt:

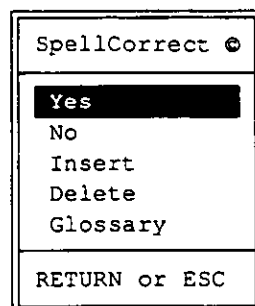

**G**

4 Press **G** (for Glossary)

Your screen will prompt:

GLOSSARY
Input
Output
Clear
List
RETURN or ESC

**I**  
INS CODE

5 Press **I** to Input the text into the Glossary

Your screen will prompt:

INPUT TO GLOSSARY FROM:
Text Name [ ]
RETURN - Enter/List, RELOC - Enter All or ESC

6 Type the name of the text containing the words to be input into the glossary

7 Press **RETURN**

The typewriter will "beep" to confirm that the words have been input into the user glossary.

- If you type a text name that does not exist, the screen will prompt:

NOT LOCATED!
--------------

Press **ESC** and enter the correct text name and press **RETURN**

QUICK  
ERASE  
ESC

8 Press **ESC** twice to exit

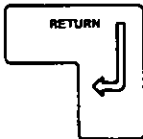

---

## Exercise

Create a new text and name it **ADDWORDS**. Type the following medical terms into the text and close the text when finished.

Nephrosis, cerebrosis, enteropathy, hepatosis

Following the instructions above, and input the text **ADDWORDS** into the glossary. Your glossary should contain a total of eight words, the four you added individually and the four you just added.

## Outputting a Glossary to Text Memory



- 1 Press the **SPELLCORRECT** key in the typewriter mode

The screen will prompt:

SpellCorrect ©
<b>Yes</b>
No
Insert
Delete
Glossary
RETURN or ESC



- 2 Press **G** (for Glossary)

Your screen will prompt:

GLOSSARY
<b>Input</b>
Output
Clear
List
RETURN or ESC



- 3 Press **O** to Output the glossary to a text

The screen will prompt:

OUTPUT FROM GLOSSARY TO:
Text Name [ ]
RETURN/RELOC to Enter or ESC

4 Type a new text name

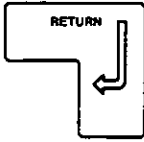

5 Press **RETURN**

The typewriter will “beep” once to confirm and the Glossary menu will be displayed.

- If you try to output the glossary to an existing text, your screen will prompt:

XXXXXXXXXX EXISTS
<b>Overwrite</b> Rename

Press **O** to Overwrite the existing text with the glossary

or

Press **R** to Rename the output file

Your screen will prompt:

RENAME
New Name    [ ■ ]
RETURN/RELOC to Enter or ESC

Type a new text name to output the glossary to and press **RETURN**



6 Press **ESC** twice to exit

### Exercise

Following the instructions above, output the current glossary to a text and name the text **MEDTERMS**.

Print the text, **MEDTERMS**. It should contain the eight words you added.

# List

The List feature enables you to display or print the words contained in the glossary. This feature is convenient when you want to check if a word was inserted into or deleted from the user glossary.

If the user glossary does not contain any words, the screen will prompt:

NOT LOCATED!

## Listing the Glossary

SPELL  
CORRECT

1 Press the **SPELLCORRECT** key in typewriter mode

G

2 Press **G** (for Glossary)

Your screen will prompt:

GLOSSARY
Read
Write
Clear
List
RETURN or ESC

L

3 Press **L** (for List)

Your screen will prompt:

LIST
Display
Print
RETURN or ESC

D  
DEFAULT

4 Press **D** (for Display)

The words in the Glossary will be displayed on screen.

---

## Printing the Glossary

- 1 Repeat steps 1-3 under "Listing the Glossary"

Your screen will prompt:

LIST
Display
Print
RETURN or ESC

- 2 Auto insert a sheet of paper



- 3 Press **P** (for Print)

# Clear

The clear feature enables you to clear the entire user glossary. Separate glossaries can be created for different applications. You could create one glossary containing medical terms and output it to a text memory. Once the user glossary is listed in a text memory, the user glossary can be cleared. Then a second glossary containing legal terms could be created. There is just one reason to clear a user glossary, put simply it gives you more versatility.

## Clearing a Glossary



- 1 Press the **SPELLCORRECT** key in the typewriter mode
- 2 Press **G** (for Glossary)

Your screen will prompt:

GLOSSARY
<b>Read</b>
Write
Clear
List
RETURN or ESC



- 3 Press **C** (for Clear)

Your screen will prompt:

CLEAR GLOSSARY ?
Are You Sure ?
<b>Yes</b> No

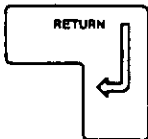

- 4 Press **RETURN** to select Yes  
or  
Press **N** to select No



- 5 Press **ESC** twice to exit



# 10. TEXT MANAGEMENT

---

This section will enable you to master the handling of your text files. The KX-E4500 enables you to advance from one phrase or text location to another for quick access without the need to exit each text. There are two selections listed on the Main Menu which are dedicated to managing your text files in the internal memory: List and More. List enables you to display or print the directory; More enables you to delete or rename files. In addition, the KX-E4500 gives you the ability to delete (clear) all text memory, all phrase memory, or all memory. The choice is yours.

# Advancing from One Phrase Location to Another

The KX-E4500 enables you to quickly advance (jump) from one phrase location to another. When you “jump” from phrase to phrase, your screen will display the first few characters of the phrase. You can jump in ascending (1–99) or descending (99–1) order through phrase locations. This is simply another way to access a phrase without the need to type in the phrase location.

**CODE** + ( **!** **1** - ( **9** ( **9** ) )

OR

**CODE** + **↓** **NEXT**

**CODE** + **↑** **PREVIOUS**

## 1 Press **CODE** + 1–99

The phrase you choose will be displayed on the screen

## 2 Press **CODE** + **INDEX** ( **↓** ) to jump in ascending order

The phrase in the next location will appear on the screen.

(example: if you initially recalled phrase number 2, when you press **CODE** + **INDEX** ( **↓** ) phrase number 3 will appear on your screen.)

OR

## Press **CODE** + **REVERSE INDEX** ( **↑** ) to jump in descending order

When you reach phrase number 99, your typewriter will beep three times if **CODE** + **INDEX** ( **↓** ) is pressed. This is to alert you that you are at the end of phrase memory. The same will happen when you reach phrase number 1 and press **CODE** + **REVERSE INDEX** ( **↑** ) .

## Advancing from One Text Location to Another

The KX-E4500 enables you to quickly advance (jump) from one text memory to another. When you “jump” from text to text, you will actually be in that text file. Jumping from text to text is only possible with the cursor positioned at the beginning of the document. You can jump forward and backward through your text files. This is simply another way to access a text memory without the need to recall the text.

**1** Recall a text



**2** Press **EXPR** to be sure your cursor is positioned at the beginning of the document.

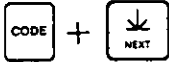

**3** Press **CODE + INDEX** ( ↓ ) to jump to the next text location

or

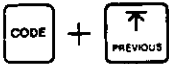

Press **CODE + REVERSE INDEX** ( ↑ ) to jump to the previous text location

or

# List

The List feature on the main menu enables you to display or print the directory of text names contained in the internal memory. It will display the text name and the amount of memory used by that file. The first line of the directory will display the total number of files in your internal memory and the remaining number of characters available in the internal memory. An asterisk (\*) before a text name indicates a forms layout file. An exclamation mark (!) before a text name indicates a phrase file.

## Displaying a List of Text Names

MAIN  
MENU

- 1 Press the **MAIN MENU** key

The screen will prompt:

MAIN MENU
<b>Create</b>
Edit
List
Print
Disk
More
RETURN or ESC

L

- 2 Press **L** (for List)

The screen will prompt:

LIST
<b>Display</b>
Print
RETURN or ESC

10



3 Press **D** (for Display)

The directory listing all text files in the internal memory will be displayed

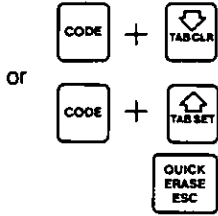

Press **CODE** + **DOWN ARROW** (⇩) to view the next screen

or

Press **CODE** + **UP ARROW** (⇧) to view the previous screen

4 Press **ESC** to exit

## Printing a List of Text Names

1 Auto insert a sheet of paper



2 Press the **MAIN MENU** key

The screen will prompt:

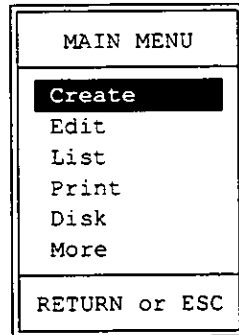

3 Press **L** (for List)

The screen will prompt:

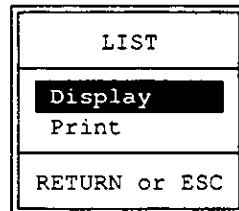

4 Press **P** (for Print)

The directory listing all text files in the internal memory will print.

# More

The More feature on the Main Menu enables you to rename a text file or delete one to eight files at a time from the internal memory.

## Renaming a Text from the Main Menu



- 1 Press the **MAIN MENU** key

The screen will prompt:

MAIN MENU
<b>Create</b>
Edit
List
Print
Disk
More
RETURN or ESC



- 2 Press **M** (for More)

The screen will prompt:

TEXT
<b>Delete</b>
Rename
RETURN or ESC



- 3 Press **R** (for Rename)

The screen will prompt:

RENAME
<b>Text Name</b> [ ]
New Name [ ]
RETURN - Enter/List, RELOC - Enter All or ESC

Type the text name

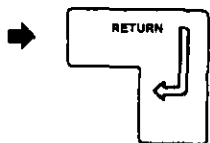

Type the new name

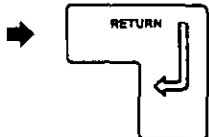

4 Type the text name to be changed and press **RETURN**

OR

Press **RETURN** to display the directory

Cursor to the desired text name and press **RETURN**

5 Type the new name and press **RETURN**

• If the new name already exists, the screen will prompt:

TEXT ALREADY EXISTS!

Press any key to return to the Rename menu

Type a different text name and press **RETURN**

6 Press **ESC** three times to exit

## Renaming a Text while in Memory

1 Access the text memory to be renamed

2 Press **CODE + N** (for Name)

The screen will prompt:

RENAME	
New Name	[ ■ ]
RETURN/RELOC to Enter or ESC	

3 Type the new name and press **RETURN**

The new text name will be displayed on the prompt line.

• If the new name already exists, the screen will prompt:

TEXT ALREADY EXISTS!

Repeat steps 2 and 3 and type a different text name

Type the new name

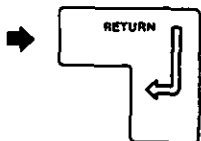

## Deleting a Text while in Memory

1 Access the text to be deleted



2 Press **EXPR** to position the cursor at the beginning of the document



3 Press **CANCEL** (  )

The screen will prompt:

CLEAR THIS TEXT ?	
Are You Sure ?	
<b>Yes</b>	No



4 Press **Y** (for Yes)

The typewriter will "beep" once to confirm and return to the typewriter mode.

or

Press **N** to clear the prompt

## Deleting a Single Text from Memory



1 Press the **MAIN MENU** key

The screen will prompt:

MAIN MENU
<b>Create</b>
Edit
List
Print
Disk
More
RETURN or ESC





2 Press **M** (for More)

The screen will prompt:

TEXT
<b>Delete</b>
Rename
RETURN or ESC



3 Press **D** (for Delete)

The screen will prompt:

DELETE
Text Name [■ ]
RETURN - Enter/List, RELOC - Enter All or ESC

4 Type the text name to be deleted

5 Press **RETURN**

The screen will prompt:

DELETE XXXXXXXXXXXX
Are You Sure ?
<b>Yes</b> No

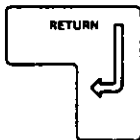

6 Press **Y** (for Yes)



7 Press **ESC** twice to return to the typewriter mode

## Deleting Multiple Texts from Memory

**MAIN MENU**

1 Press the **MAIN MENU** key

The screen will prompt:

MAIN MENU
<b>Create</b>
Edit
List
Print
Disk
More
RETURN or ESC

**M MARK**

2 Press **M** (for More)

The screen will prompt:

TEXT
<b>Delete</b>
Rename
RETURN or ESC

**D DEFAULT**

3 Press **D** (for Delete)

The screen will prompt:

DELETE
Text Name [ ]
RETURN - Enter/List, RELOC - Enter All or ESC

10

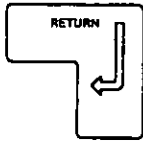

4 Press **RETURN** to display the directory as shown below

List of Memory		20 Files	1234 Characters Free
-	<b>BILLING</b> 4536	- DATE 350	- EXECUTOR 300
-	EXPENSES 2345	- FAMILY 400	- FRAME 345
-	INTENT 500	- INVITATION 570	- IMPROVE 287
-	LATEACCTS 1090	- LEGAL 7777	- LETTER 1000
-	OVERDUE 543	- PANASONIC 6666	- PERMIT 7000
-	PROPERTY 5678	- RISK 287	- SHARES 287
-	TEXT1 333	- TRAVEL 290	

To Select/Cancel: Press Spacebar, RETURN to execute, ESC to exit

5 Highlight the text name to be deleted

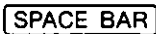

6 Press **SPACE BAR**

An asterisk will appear on the line before the text name.

7 Repeat steps 5 and 6 for each text to be deleted (maximum 8 files)

The typewriter will "beep" three times if you try to delete more than 8 files at one time.

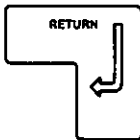

8 Press **RETURN**

The screen will prompt:

ARE YOU SURE Y/N?



or



9 Press **Y** (for Yes)

All files selected are deleted.

or

Press **N** (for No) and press **ESC** three times to exit

# Clearing All Text Memory

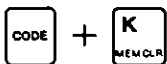

**1** Press **CODE + K** (for Clear Memory)

The screen will prompt:

CLEAR MEMORY
<b>Text</b>
Phrase
All Memory
RETURN or ESC

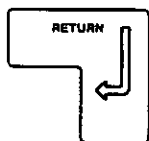

**2** Press **RETURN** to select Text

The screen will prompt:

CLEAR ALL TEXTS ?
Are You Sure ?
<b>Yes</b> No



**3** Press **Y** (for Yes)

The typewriter will “beep” once to confirm that all text files are deleted.

or

Press **N** (for No) to exit

# Clearing All Phrase Memory

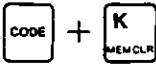

1 Press **CODE + K** (for Clear Memory)

The screen will prompt:

CLEAR MEMORY
<input checked="" type="radio"/> Text
<input type="radio"/> Phrase
<input type="radio"/> All Memory
RETURN or ESC



2 Press **P** (for Phrase)

The screen will prompt:

CLEAR ALL PHRASES ?
Are You Sure ?
<input checked="" type="radio"/> Yes <input type="radio"/> No



3 Press **Y** (for Yes)

The typewriter will “beep” once to confirm that all phrase locations are cleared.

or

Press **N** (for No) to exit

# Clearing All Memory

When using **CODE + K** if All Memory is selected, all phrases and text memory are deleted. In addition, all margin formats (rulers X, Y, and Z) are cleared and the machine returns to all default settings.

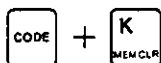

- 1 Press **CODE + K** (for Clear Memory)

The screen will prompt:

CLEAR MEMORY
<b>Text</b>
Phrase
All Memory
RETURN or ESC



- 2 Press **A** to select All Memory

The screen will prompt:

CLEAR ALL MEMORY ?
Are You Sure ?
<b>Yes</b> No



- 3 Press **Y** (for Yes)

The typewriter will “beep” once to confirm that all text files are deleted.

or

Press **N** (for No) to exit

## Resetting the Printer

It may be necessary to reset the printer if the system is not printing properly. When the printer is reset, the screen will temporarily go blank, the daisywheel will spin, and the printhead will move to the left end of the platen before returning to the left margin. No memory will be lost and all default settings will remain. It is as if you shut the typewriter off and turned it back on.

If you reset the printer while in memory, you will automatically exit text memory and return to the typewriter mode. The document will not be effected and it will remain in the memory, even if you were creating a document and did not close it.

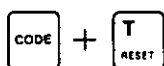

### 1 Press **CODE + T**

The screen will prompt:

RESET PRINTER ?	
Are You Sure ?	
<b>Yes</b>	No



### 2 Press **Y** (for Yes)

or

Press **N** (for No)

## Displaying the Amount of Memory Available

The KX-E4500 enables you to display the number of characters available in the memory.

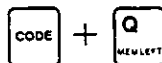

### • Press **CODE + Q**

Your screen will prompt:

MEMORY LEFT (# Ch. available)
-------------------------------

This prompt will clear upon activating any other command.

# 11. DISK

---

The KX-E4500 disk drive is located on the left side of the typewriter. The disk drive uses 3.5" double sided, double density disks. Each disk has approx. 720,000 characters storage capacity. That's roughly 360 pages of information. A total of 112 texts can be stored to disk.

Before text files can be stored to disk, you must first prepare the disk for use on the KX-E4500. This is done through a procedure called "Formatting." When you format a disk, 7,000 characters are used for programming instructions.

The KX-E4500 has simplified all disk operations through the Main Menu key. All disk applications are accessed under the Disk selection listed on the Main Menu.



## Disk Menu Overview

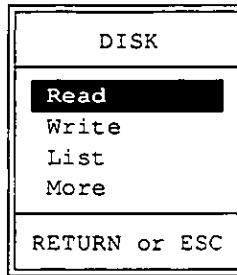

- |              |   |
|--------------|---|
| <b>Read</b>  | Copies one to eight text files from disk into the internal memory.  |
| <b>Write</b> | Stores one to eight text files from the internal memory onto disk.  |
| <b>List</b>  | Enables you to display or print the disk directory.   |
| <b>More</b>  | Deletes one to eight text files from the disk<br>Renames files on the disk<br>Prints files directly from disk<br>Formats the disk<br>Enables you to read text files created on other Panasonic typewriters with single density drives<br>Enables you to read ASCII files into the internal memory |

## Inserting a Micro-Floppy Disk

- 1 Insert the disk into the disk drive with the metal tab and the arrow pointing toward the typewriter as shown.

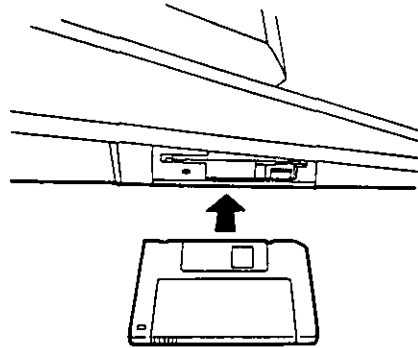

- 2 Gently push the disk until it clicks and the eject button pops out.
- Never turn the Power switch on or off when a disk is installed in the disk drive.
  - Never insert or remove a disk while the Access Indicator is lit.

## Ejecting a Micro-Floppy Disk

- Push the Eject Button

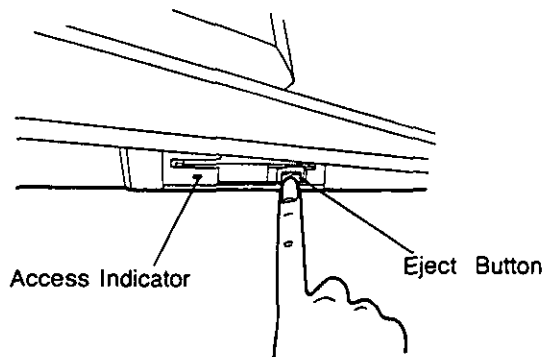

# Protecting a Micro-Floppy Disk from Erasure

The disk can be protected against accidental erasure. When the disk is protected, you cannot format, store, rename or delete documents. You can however, still read files from the disk into memory and also print files directly from disk.

## To protect a disk:

- Slide the button toward the base of the cartridge so that a hole appears.

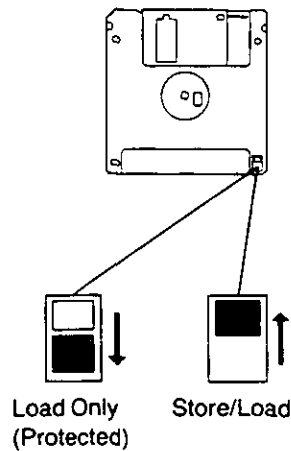

If you try to store on or format a protected disk, the display will prompt:

PROTECTED DISK!

## To remove the Protection:

- Slide the button toward the top of the cartridge to close the hole.

# Formatting a Disk

Formatting prepares the disk for the type of machine you are using. Each disk must be formatted before it can be used. If there is information on the disk, it will automatically be erased when the disk is formatted.

**MAIN  
MENU**

## 1 Press **MAIN MENU**

Your screen will prompt:

MAIN MENU
<b>Create</b>
Edit
List
Print
Disk
More
RETURN or ESC

**D  
DEFAULT**

## 2 Type **D** (for Disk)

Your screen will prompt:

DISK
<b>Read</b>
Write
List
More
RETURN or ESC

**M  
MARK**

## 3 Press **M** (for More)

Your screen will prompt:

DISK
<b>Delete</b>
Rename
Print
Format
Load from 1DD Panasonic Disk
ASCII file Load from PC Disk
RETURN or ESC



**4** Press **F** (for Format)

Your screen will prompt:

FORMAT THIS DISK ?	
Are You Sure ?	
<b>Yes</b>	No



/



**5** Press **Y** (for Yes)

Your screen will prompt:

FORMATTING
------------

or

Press **N** (for No) to exit the format selection

When formatting is complete, your screen will return to the disk menu.



**6** Press **ESC** to exit

# Write

The write operation enables you to copy one or multiple text files from the internal memory to disk. When a file is written to disk it remains in the internal memory as well. Therefore, the same file will be located in two places. After writing a text to disk, it is suggested that you clear it from the internal memory.

A maximum of 112 texts can be written to the disk. If you attempt to write more than 112 text files, your screen will prompt:

```
          DIRECTORY FULL!
```

If you attempt to write more than 720,000 characters to disk, the screen will prompt:

```
          DISK FULL!
```

## Writing a Single Text to Disk

**D**  
MAIN  
MENU

### 1 Press MAIN MENU

The screen will prompt:

```
          MAIN MENU
          Create
          Edit
          List
          Print
          Disk
          More
          RETURN or ESC
```

**D**  
DEFAULT

### 2 Press D (for Disk)

The screen will prompt:

```
          DISK
          Read
          Write
          List
          More
          RETURN or ESC
```



**3** Press **W** (for Write)

The screen will prompt:

WRITE	
Text Name	[ ]
RETURN - Enter/List, RELOC - Enter All or ESC	

**4** Type the text name to be copied to disk

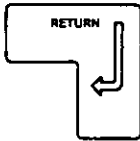

**5** Press **RETURN**

The typewriter will temporarily display "MACHINE IS BUSY" and then display "WRITING." When the write is complete, the disk menu will be displayed.



**6** Press **ESC** twice to exit

## Writing Multiple Texts to Disk

MAIN  
MENU

### 1 Press MAIN MENU

The screen will prompt:

MAIN MENU
Create
Edit
List
Print
Disk
More
RETURN or ESC

D  
DEFAULT

### 2 Press D (for Disk)

The screen will prompt:

DISK
Read
Write
List
More
RETURN or ESC

W  
DUAL COL.

### 3 Press W (for Write)

The screen will prompt:

WRITE
Text Name [■ ]
RETURN - Enter/List, RELOC - Enter All or ESC

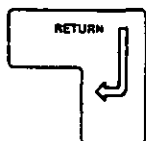

### 4 Press RETURN to display the directory

### 5 Highlight the text name to be written to disk

SPACE BAR

### 6 Press SPACE BAR to confirm the selection

An asterisk will appear to the left of each text to be copied to disk



- 
- 7 Repeat steps 5 and 6 for each text to be written (maximum 8 files)

The typewriter will “beep” three times if you try to write more than eight files at one time.

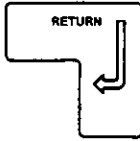

- 8 Press **RETURN**

The typewriter will temporarily display “MACHINE IS BUSY” and then display “WRITING.” When the write is complete, the disk menu will be displayed.

- If the text name already exists on the disk, the screen will prompt:

XXXXXXXXXX	EXISTS
<b>Overwrite</b>	Rename

To Replace the existing file with the new one:

- Press **RETURN** to select Overwrite

To Rename the text you are writing to disk:

- RIGHT ARROW** (↷) once and press **RETURN**

The screen will prompt:

RENAME	
New Name	[ █ ]
RETURN/RELOC to Enter or ESC	

- Type a new name and press **RETURN**

If this name also already exists on disk, the Rename menu will display again. Type another name and press **RETURN**.



- 9 Press **ESC** twice to exit

## Read

The Read operation enables you to copy one or multiple texts (Maximum of 8) from the disk to the internal memory. Only a copy is read into memory, the original text remains on disk.

The prompt "MEMORY FULL!" will be displayed when the entire capacity of the internal memory has been used. Therefore, check the memory available (CODE+Q) before reading into the internal memory. If necessary, delete unwanted texts, or write them to disk and clear from the internal memory before reading new texts in.

If no disk is in the drive when you try to read, the screen will prompt:

NO DISK!

If you try to read a disk which does not have a format that the KX-E4500 can read, the screen will prompt:

ILLEGAL DISK FORMAT!

# Reading a Single Text into Memory



1 Press **MAIN MENU**

The screen will prompt:

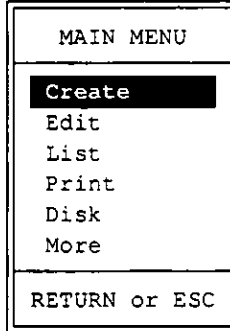

2 Press **D** (for Disk)

The screen will prompt:

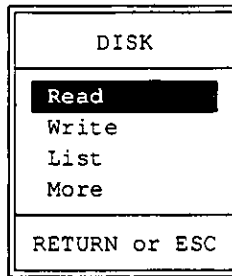

3 Press **R** (for Read)

The screen will prompt:

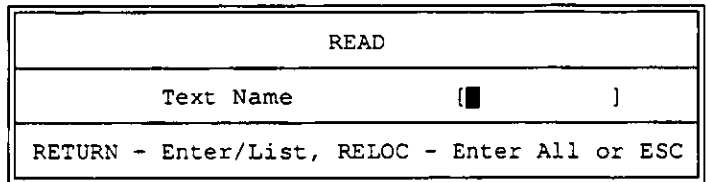

4 Type the text name to be copied into the internal memory

5 Press **RETURN**

The screen will prompt "READING." When the read is complete, the disk menu will be displayed.

6 Press **ESC** twice to exit

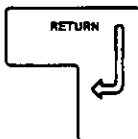

## Reading Multiple Texts into Memory



### 1 Press **MAIN MENU**

The screen will prompt:

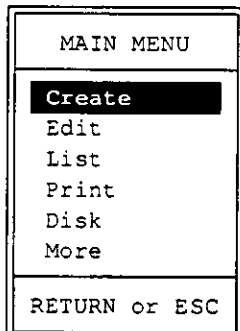

### 2 Press **D** (for Disk)

The screen will prompt:

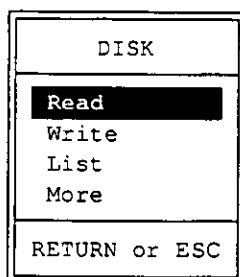

### 3 Press **R** (for Read)

The screen will prompt:

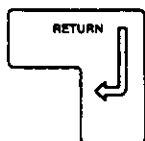
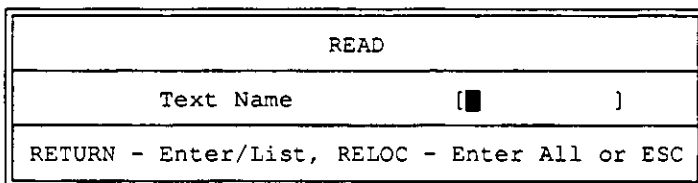

### 4 Press **RETURN** to display the disk directory

### 5 Highlight the text name to be read into the internal memory.

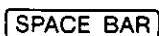

### 6 Press **SPACE BAR** to confirm the selection

An asterisk will appear to the left of each text to be copied into the typewriter.

- 
- 7 Repeat steps 5 and 6 for each text to be read (maximum 8 files)

The typewriter will “beep” three times if you try to read more than eight files at one time.

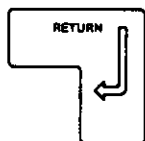

- 8 Press **RETURN**

The screen will prompt “READING.” When the read operation is complete, the disk menu will be displayed.

- If the text name already exists in the internal memory, the screen will prompt:

XXXXXXXXXX	EXISTS
<b>Overwrite</b>	Rename

To Replace the existing file with the new one:

- Press **RETURN** to select Overwrite

To Rename the text you are reading into memory:

- RIGHT ARROW** (↵) once and press **RETURN**

The screen will prompt:

RENAME	
New Name	[█ ]
RETURN/RELOC to Enter or ESC	

- Type a new name and press **RETURN**

If this name also exists in the internal memory, the Rename menu will reappear. Type another name and press **RETURN**.



- 9 Press **ESC** twice to exit

# List

The List feature on the disk menu enables you to display or print the directory of text names stored on the disk. It will display the text name and the amount of memory used by that file. On the first line of the directory it will display the remaining number of characters free on the disk. An asterisk (\*) before a text name indicates a forms layout file. An exclamation mark (!) before a text name indicates a phrase text file.

## Displaying a Disk Directory

MAIN  
MENU

- 1 Press the **MAIN MENU** key

The screen will prompt:

MAIN MENU
<b>Create</b>
Edit
List
Print
Disk
More
RETURN or ESC

D  
DEFAULT

- 2 Press **D** (for Disk)

The screen will prompt:

DISK
<b>Read</b>
Write
List
More
RETURN or ESC

L

- 3 Press **L** (for List)

The screen will prompt:

LIST
<b>Display</b>
Print
RETURN or ESC



#### 4 Press **D** (for Display)

The disk directory will be displayed.

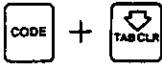

Press **CODE + DOWN ARROW** (⇩) to view the next screen

or



Press **CODE + UP ARROW** (⇧) to view the previous screen



#### 5 Press **ESC** to exit

---

## Printing a Disk Directory

1 Auto insert a sheet of paper



2 Press the **MAIN MENU** key

The screen will prompt:

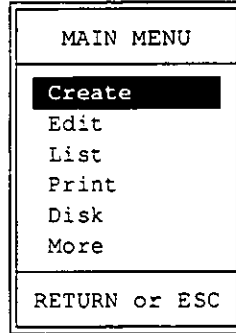

3 Press **D** (for Disk)

The screen will prompt:

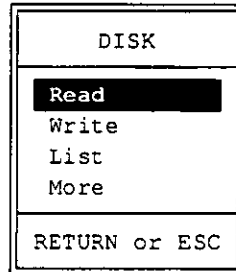

4 Press **L** (for List)

The screen will prompt:

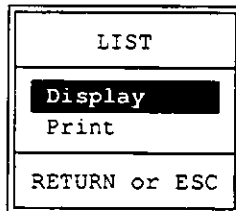

5 Press **P** (for Print)

The disk directory listing all text files will print.



# More

The More feature on the Disk Menu enables you to rename a text file stored on disk or delete one to eight files at a time from the disk. In addition the more feature enables you to print directly from disk.

## Renaming a Text on Disk

MAIN  
MENU

- 1 Press the **MAIN MENU** key

The screen will prompt:

MAIN MENU
<b>Create</b>
Edit
List
Print
Disk
More
RETURN or ESC

D  
DEFAULT

- 2 Press **D** (for Disk)

The screen will prompt:

DISK
<b>Read</b>
Write
List
More
RETURN or ESC



### 3 Press M (for More)

The screen will prompt:

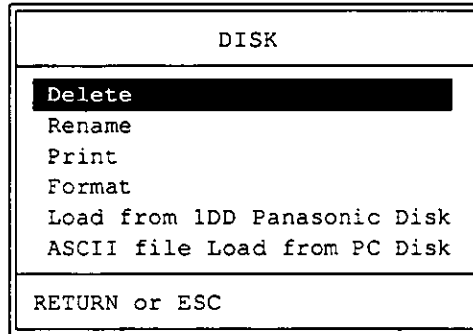

### 4 Press R (for Rename)

The screen will prompt:

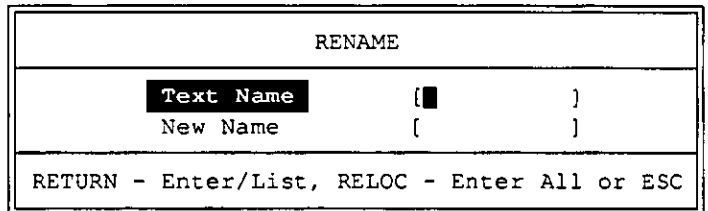

Type the text name

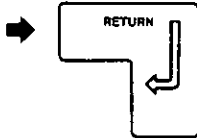

Type the new name

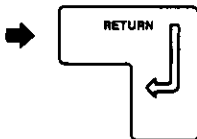

### 5 Type the text name to be changed and press RETURN

OR

Press RETURN to display the directory

Cursor to the desired text name and press RETURN

### 6 Type the new name and press RETURN

- If the new name already exists, the screen will prompt:

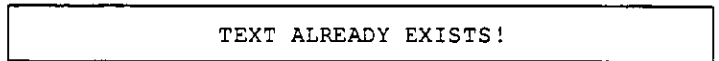

Press any key to return to the rename menu

Type a different text name and press RETURN



### 7 Press ESC three times to exit

## Deleting a Single Text from Disk

**MAIN  
MENU**

- 1 Press the **MAIN MENU** key

The screen will prompt:

MAIN MENU
<b>Create</b>
Edit
List
Print
Disk
More
RETURN or ESC

**D  
DEFAULT**

- 2 Press **D** (for Disk)

The screen will prompt:

DISK
<b>Read</b>
Write
List
More
RETURN or ESC

**M  
MARK**

- 3 Press **M** (for More)

The screen will prompt:

DISK
<b>Delete</b>
Rename
Print
Format
Load from 1DD Panasonic Disk
ASCII file Load from PC Disk
RETURN or ESC



4 Press **D** (for Delete)

The screen will prompt:

DELETE	
Text Name	[■ ]
RETURN - Enter/List, RELOC - Enter All or ESC	

5 Type the text name to be deleted from disk

6 Press **RETURN**

The screen will prompt:

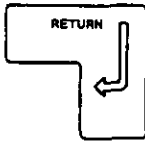

DELETE XXXXXXXXXXXX	
Are You Sure ?	
<input checked="" type="checkbox"/> Yes	<input type="checkbox"/> No



7 Press **Y** (for Yes)

The screen will prompt, "DELETING."



8 Press **ESC** twice to exit

## Deleting Multiple Texts from Disk

**MAIN  
MENU**

- 1 Press the **MAIN MENU** key

The screen will prompt:

MAIN MENU
<b>Create</b>
Edit
List
Print
Disk
More
RETURN or ESC

**D  
DEFAULT**

- 2 Press **D** (for Disk)

The screen will prompt:

DISK
<b>Read</b>
Write
List
More
RETURN or ESC

**M  
MARK**

- 3 Press **M** (for More)

The screen will prompt:

DISK
<b>Delete</b>
Rename
Print
Format
Load from 1DD Panasonic Disk
ASCII file Load from PC Disk
RETURN or ESC



**4** Press **D** (for Delete)

The screen will prompt:

DELETE	
Text Name	[█]
RETURN - Enter/List, RELOC - Enter All or ESC	

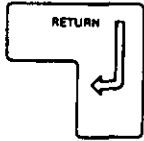

**5** Press **RETURN** to display the directory as shown below

List of Disk		20 Files	650K Characters Free					
-	<b>BILLING</b>	5K	-	DATE	1K	-	EXECUTOR	1K
-	EXPENSES	3K	-	FAMILY	1K	-	FRAME	1K
-	INTENT	1K	-	INVITATION	1K	-	IMPROVE	1K
-	LATEACCTS	2K	-	LEGAL	8K	-	LETTER	1K
-	OVERDUE	1K	-	PANASONIC	7K	-	PERMIT	7K
-	PROPERTY	6K	-	RISK	1K	-	SHARES	1K
-	TEXT1	1K	-	TRAVEL	1K			

To Select/Cancel: Press Spacebar, RETURN to execute, ESC to exit

**6** Highlight the text name to be deleted



**7** Press **SPACE BAR** to confirm

An asterisk will appear to the left of the text to be deleted.

**8** Repeat steps 6 and 7 for each text to be deleted (maximum 8 files)

The typewriter will "beep" three times if you try to delete more than 8 files at one time.

**9** Press **RETURN**

The screen will prompt:

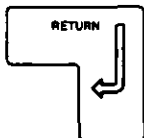

ARE YOU SURE Y/N?
-------------------

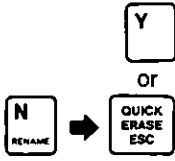

**10** Press **Y** (for Yes)

All files selected are deleted.

The screen will prompt:

DELETING

OR

Press **N** (for No) and press **ESC** three times to exit

QUICK  
ERASE  
ESC

**11** Press **ESC** twice to exit

## Printing a Text from Disk

1 Auto insert a sheet of paper



2 Press the **MAIN MENU** key

The screen will prompt:

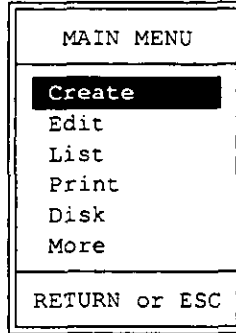

3 Press **D** (for Disk)

The screen will prompt:

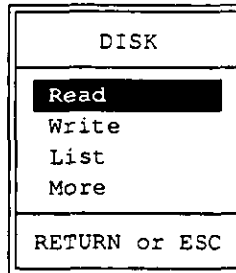

4 Press **M** (for More)

The screen will prompt:

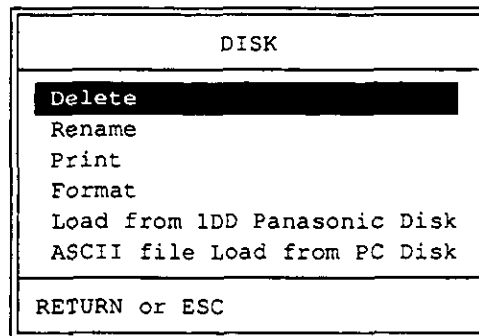





**5** Press **P** (for Print)

The screen will prompt:

PRINT	
Text Name	[■ ]
RETURN - Enter/List, RELOC - Enter All or ESC	

**6** Type the text name to print

or

Press **RETURN** to display the disk directory

Highlight the text name to be printed

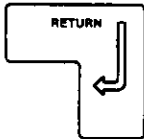

**7** Press **RETURN**

The text will print.

---

## Loading Texts from Other Panasonic Typewriters

The KX-E4500 enables you to read text created on the following Panasonic typewriters except forms layout:

KX-E7000, KX-ED20, KX-E700m, and KX-ED4. The disks used by these Panasonic typewriters are single sided, double density 3.5" disks.

**1** Insert the single sided Panasonic Typewriter disk



**2** Press **MAIN MENU**

The screen will prompt:

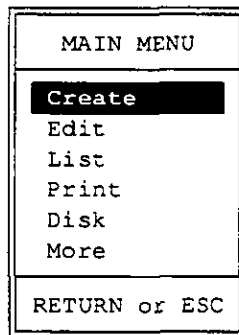

**3** Press **D** (for Disk)

The screen will prompt:

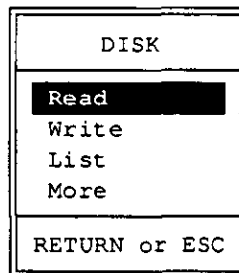

**M**  
MARK

**4** Press **M** (for More)

The screen will prompt:

DISK
<b>Delete</b>
Rename
Print
Format
Load from 1DD Panasonic Disk
ASCII file Load from PC Disk
RETURN or ESC

**L**

**5** Press **L** (for Load from 1DD Panasonic Disk)

The screen will prompt:

LOAD FROM 1DD PANASONIC DISK
Text Name            [■            ]
RETURN - Enter/List, RELOC - Enter All or ESC

**6** Type the text name to be copied into the typewriter

or

Press **RETURN** to display the disk directory

Highlight the text to be read

Press **SPACE BAR** to confirm your selection (maximum 8 files)

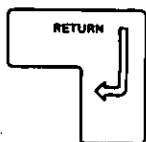

**7** Press **RETURN**

The screen will prompt:

READING
---------

**QUICK  
ERASE  
ESC**

**8** Press **ESC** three times to exit

---

## Loading an ASCII file

The KX-E4500 gives you the ability to read disks that were created in an ASCII format. Most files created on a PC word processing package can be converted to an ASCII file and then read into the KX-E4500. Keep in mind that files created on the Panasonic KX-E7500 can also be converted to an ASCII file and read into the KX-E4500.

The KX-E4500 can only read one ASCII file at a time.

**1** Insert the disk containing the ASCII file



**2** Press **MAIN MENU**

The screen will prompt:

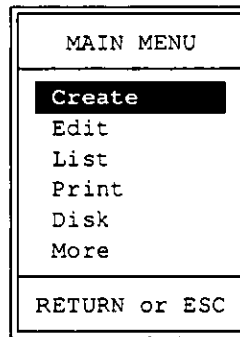

**3** Press **D** (for Disk)

The screen will prompt:

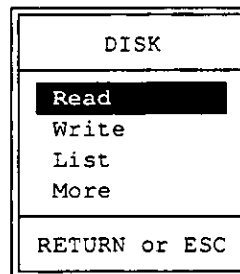



**4 Press M (for More)**

The screen will prompt:

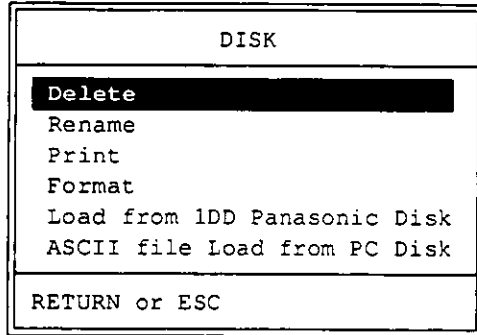

**5 Press A (for ASCII file Load from PC Disk)**

The screen will prompt:

List of Disk			20 Files	650K Characters Free		
<b>BILLING</b>	<b>TXT</b>	<b>5K</b>	DATE	TXT 1K	EXECUTOR	TXT 1K
EXPENSES	TXT	3K	FAMILY	TXT 1K	FRAME	TXT 1K
INTENT	TXT	1K	INVITATI	TXT 1K	IMPROVE	TXT 1K
LATEACCT	TXT	2K	LEGAL	TXT 8K	LETTER	TXT 1K
OVERDUE	TXT	1K	PANASONI	TXT 7K	PERMIT	TXT 7K
PROPERTY	TXT	6K	RISK	TXT 1K	SHARES	TXT 1K
TEXT1	TXT	1K	TRAVEL	TXT 1K		

To Select: Highlight Name and Press RETURN, ESC to exit

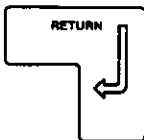

**6 Highlight the desired selection and press RETURN**

Your prompt line will display the word **READING**.

When the typewriter is through reading the information, the Disk menu will reappear on the screen. The ASCII file is now in the typewriter's internal memory.



**7 Press ESC three times to return to typewriter mode**

# 12-1 SCREEN MESSAGES

## Messages

## Description

**Alternatives, Skip, Insert, Quit?**

Do you want to display alternatives, skip the word, insert the word into the glossary or quit the SpellCorrect?

**ARE YOU SURE Y/N?**

Prompt displayed when clearing text from internal memory or disk.

**Cannot Access! This File is in Print Queue**

The text is currently in the Print Queue. Either wait for the text to print or delete it from the queue.

**CANNOT COPY**

The phrase you want to copy does not exist.

**Cannot perform while Background Printing**

You are now executing Print Queue. You cannot perform this command.

**CANNOT SET HERE**

You have tried to set the frame corner in an improper area while line framing.

**CODE**

CODE key is activated.

**COLUMN LAYOUT**

Column Layout mode was entered.

**Correct, Skip, Quit?**

Do you want to delete the second word, skip the word or quit the SpellCorrect?

**Deleted**

The word in the glossary was deleted.

**DELETING**

The typewriter is deleting text from the disk.

**DIRECTORY FULL!**

The maximum of 112 texts were entered on the disk directory.

**DISK ERROR!**

Information cannot be accessed or the disk is not formatted.

**DISK FULL!**

Entire disk capacity has been used.

**FORMATTING**

The typewriter is formatting a disk.

**FRAME CORNER WAS SET**

The corner of a line frame box was set at this point.

**GLOSSARY FULL!**

Entire capacity of the Spell Glossary has been used.

**ILLEGAL DISK FORMAT!**

Disk in drive is not a Panasonic or ASCII format.

**ILLOGICAL PRINTER REQUEST**

An illogical printer request was entered into a text. The typewriter cannot perform this request.

**Inserted**

The word was inserted into the glossary.

**LID OR SUPPLY**

The cover is open or the typewriter is out of ribbon.

**LOW BATTERY!**

Battery level is low. Replace the batteries before turning the typewriter off.

**MACHINE IS BUSY**

The machine is still completing your last instruction. Wait for completion.

**MARGIN OVER**

You have exceeded the right margin. (Right Margin Release)

**MEMORY FULL!**

Entire capacity of the internal memory has been used.

---

## Messages

**MEMORY LEFT**

## Description

The numeric value represents the number of characters left in memory.

**NO ALTERNATIVES!**

There are no Alternatives for the misspelled word.

**NO DISK!**

A disk is not set in the disk drive.

**NOT LOCATED!**

The requested information is not in memory.

**PAGE END !!**

You have reached the last line of the preset page ending.

**PRESS ANY KEY!**

Press any key to advance to next screen of the glossary list.

**PRINTING**

The typewriter is printing a text or phrase.

**PROTECTED DISK!**

Your disk has been protected. You cannot write, clear, rename or format on this disk.

**READING**

The typewriter is reading the texts on the disk into memory.

**RENAMING**

The typewriter is renaming a text.

**Replace, Skip, Quit?**

Do you want to replace the word/skip the word or quit selective search and replace?

**RIGHT MARGIN OVER**

In column layout, you have exceeded the right margin.

**TEXT ALREADY EXISTS!**

The same text name is already stored in memory.

**TOO MANY STOP POINTS**

You have tried to enter more tabs than the maximum number of tab stops (99) allowed within your form layout.

**TOO MANY TAB STOPS**

You have exceeded the maximum number of tab stops (28) allowed on a writing line.

**TOP OF FORM**

The top of forms layout.

**WORD NOT IN GLOSSARY!**

You have tried to delete a word that does not appear in the glossary.

**WRITING**

The typewriter is writing text in memory onto the disk.

**WRONG COLUMN**

A dual column format was not recalled before pressing CODE + W.

# 12-2 CODE OPERATIONS CHART

<b>CODE</b>	<b>FUNCTION</b>	<b>PAGE</b>
<b>CODE + A</b>	Set auto paper insertion	25
	Append text	110
<b>CODE + B</b>	Bold print	42
<b>CODE + C</b>	Word change (Global search & replace)	80
<b>CODE + D</b>	Default settings	10
<b>CODE + E</b>	Auto paper eject	26
<b>CODE + F</b>	Margin format edit/recall/store or line spacing	30-33, 73-75
<b>CODE + H</b>	Half space	
<b>CODE + I</b>	Insert (Stop code)	105
<b>CODE + J</b>	Jump to page	77
<b>CODE + K</b>	Memory clear	186-188
<b>CODE + L</b>	Automatic line framing	112
<b>CODE + M</b>	Block move, copy, delete and print	82
<b>CODE + N</b>	Rename text	181
<b>CODE + P</b>	Page end command	87
<b>CODE + Q</b>	Memory available	189
<b>CODE + R</b>	Mail merge reference code	128
<b>CODE + S</b>	Search	79
<b>CODE + T</b>	Reset printer and correction memory	189
<b>CODE + U</b>	Required backspace	53
<b>CODE + V</b>	Hyphen scan	76
<b>CODE + W</b>	Dual column typing	119
<b>CODE + 0 (Zero)</b>	Phrase list, read, write	62-65
<b>CODE + 1-99</b>	Phrase memory access	59

12



<b>CODE</b>	<b>FUNCTION</b>	<b>PAGE</b>
<b>CODE + BACKSPACE</b>	Fast scroll word by word to the left	56
<b>CODE + CANCEL (⊗)</b>	Escape correction memory	38
<b>CODE + EXPR</b>	Forms layout	144
<b>CODE + FWD→</b>	Fast scroll word by word to the right	56
<b>CODE + HYPHEN (-)</b>	Temporary hyphen	51
<b>CODE + ↵ IND</b>	Block indent	48
<b>CODE + INDEX (↓)</b>	Access next text	177
	Access next phrase	176
	Next line in correction memory	37
	Next stop position during forms layout	
	Next search word position	79
<b>CODE + R/INDEX (↑)</b>	Access previous text	177
	Access previous phrase	176
	Previous line in correction memory	37
	Previous stop position during forms layout	151
	Previous search word position	79
<b>CODE + L.MGN</b>	Column layout	103
<b>CODE + LOCK</b>	Caps lock	42
<b>CODE + PRINT</b>	No print	38
<b>CODE + QUICK ERASE</b>	Deletes from the cursor position to the beginning of the line	57
<b>CODE + RETURN</b>	Manual return code when searching and changing word	78
	Controlled printer movement	23
<b>CODE + R.MGN</b>	Set new bell position for the hot zone	29
<b>CODE + SPACE BAR</b>	Micro space	52

<b>CODE</b>	<b>FUNCTION</b>	<b>PAGE</b>
<b>CODE + TAB CLR</b>	Clear margins and tabs	28
<b>CODE + /</b>	Mail list record header	132
<b>CODE + =</b>	Embed/display non-printable symbols	22
<b>CODE + Up Cursor (⬆)</b>	Top of previous screen	56
<b>CODE + Down Cursor (⬇)</b>	Top of next screen	56
<b>CODE + Left Cursor (⬅)</b>	Beginning of line	56
<b>CODE + Right Cursor (➡)</b>	End of line	56
<b>CODE + <u>XXX</u></b>	Underscore by word	44
<b>SHIFT + INDEX (⌞)</b>	Advance the paper 1/48 of an inch toward the bottom of page	26
<b>SHIFT + R/INDEX (⌟)</b>	Advance the paper 1/48 of an inch toward the top of page	26
<b>SHIFT + SPACE BAR</b>	Permanent space	52
<b>SHIFT + <u>XXX</u></b>	Double underscore	44

## 12-3 CAUTIONS

Be sure that the carrier stopper which holds the printer stationary during shipping is removed before turning the unit on. Keep this stopper so that the unit can be transported safely, if the need arises.

For the best possible operation of your typewriter, do not use a power outlet which is presently being used for a copier or other device which consumes a large volume of power.

Do not use your typewriter in the following environmental conditions:

- In direct sunlight where additional heat will be generated.
- In areas where the atmosphere is extremely salty or where corrosive gases are present.
- On surfaces that are not flat, or subject to vibration.

### Batteries

If improperly used, the batteries may leak and cause corrosion. Therefore, observe the following:

- Insert batteries properly so that the polarity matches the plus (+) and minus (-) positions indicated in the bottom of the battery compartment.
- Do not use new and old batteries together.
- Do not use batteries of different types together. Some batteries differ in voltage, even though they have the same shape.
- Do not attempt to recharge the batteries.

### Cleaning

Use only a soft, dry cloth to clean your typewriter. Water or thinners may damage the cover, case, or electronic circuitry.

### Handling Disks

Never touch the magnetic material inside the plastic cartridge. Never expose to magnetism (telephones, loud speakers and little kitchen magnets).

12

### Cables

Both, the Serial interface (KX-EIS1) and the Parallel interface (KX-EIP1), require a shielded cable less than 6 feet in length.

# 12-4 CHANGING SUPPLIES

## Changing the Ribbon Cartridge

- 1 Lift the top cover of your typewriter
- 2 Grasp the cartridge on both sides and lift it up and out of the machine

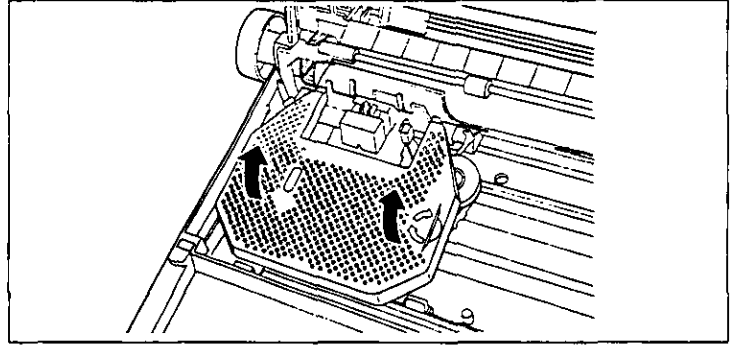

- 3 To insert a new cartridge, place the front portion (where the ribbon is exposed) between the card holder and the tape guides. Snap the back end of the cartridge onto the printer.

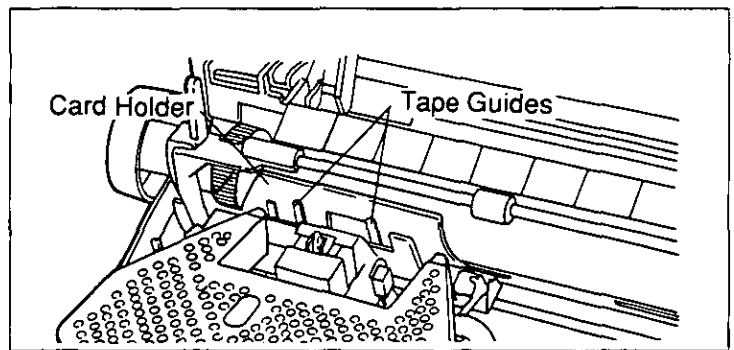

- 4 Advance the thumb wheel on the cartridge clockwise until the ribbon slack is tightened

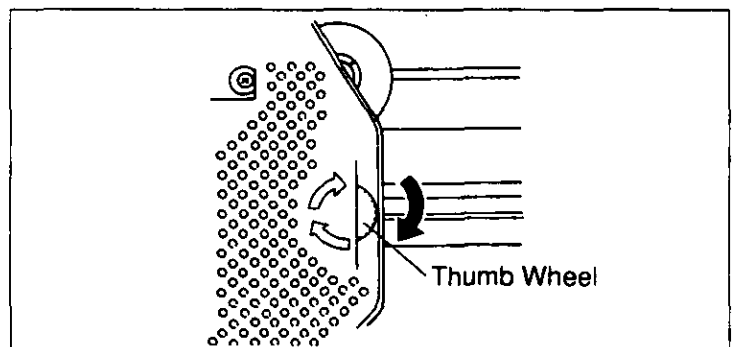

# Changing the Correction Tape

- 1 Lift out the ribbon cartridge and remove the two spools of lift-off tape

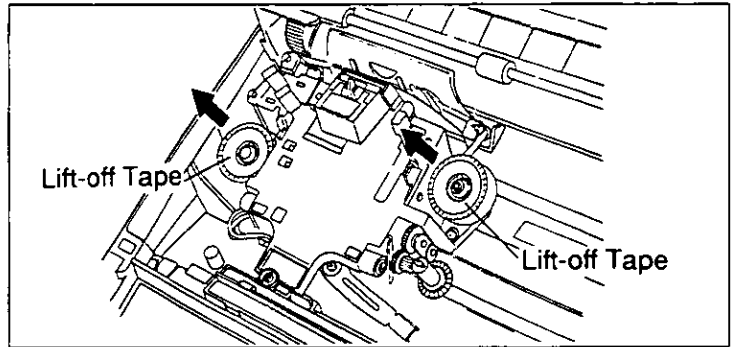

- 2 Place the loaded spool of the new tape on the left pin
- 3 Feed tape around white spools. Place empty spool on the right pin

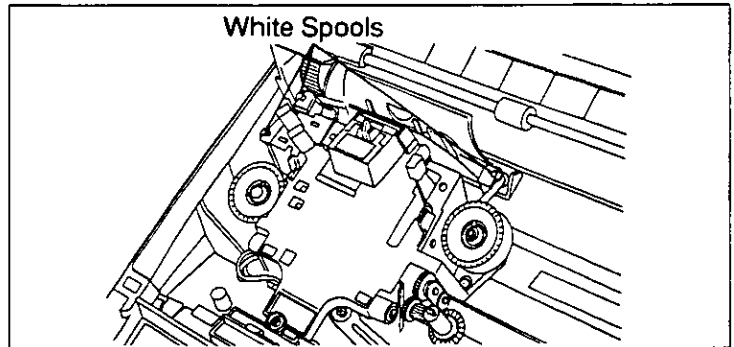

- 4 Manually turn the right hand spool counter-clockwise, tightening the tape until resistance is felt

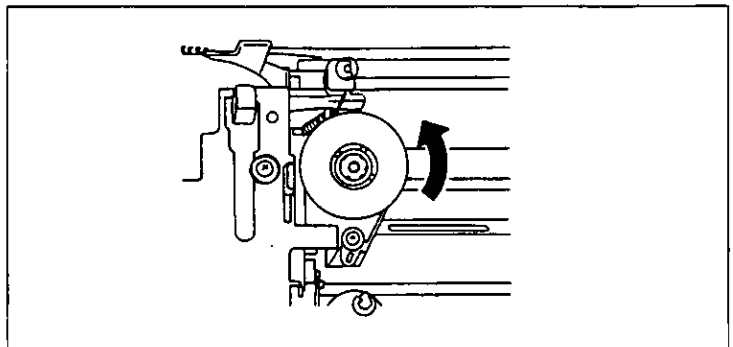

- 5 Replace the typing ribbon cartridge

## Changing the Daisywheel

- 1 Lift out the ribbon cartridge
- 2 Pull the green lever that is located to the right of the printhead towards you. Grasp the clear plastic cartridge and lift the daisywheel out of the machine

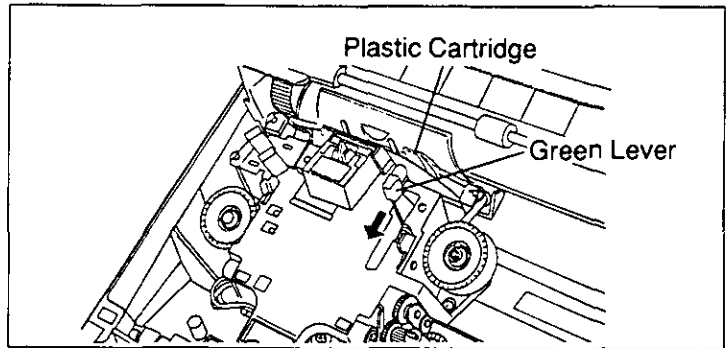

- 3 Place the plastic cartridge of another daisywheel in the carrier with the characters facing the platen. Push the right side of plastic cartridge down into the carrier and push the green lever back into position

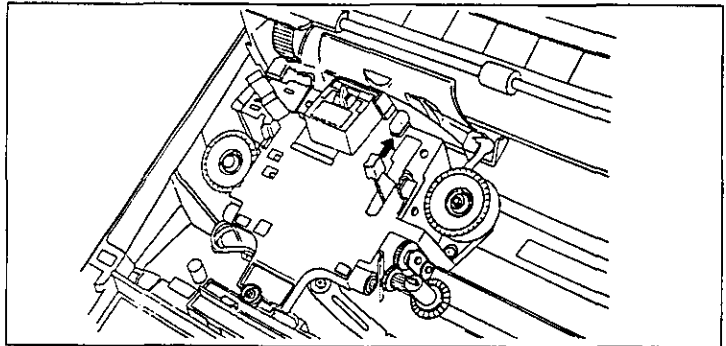

- 4 Replace the ribbon
- 5 Close the top cover

# Changing the Batteries

The unit must remain ON when the batteries are being replaced to insure that the memory remains intact.

When your typewriter is turned off, the memory (auto insertion point, formats, forms layout, etc.) is retained through three "AA" size batteries. Your typewriter will alert you when the batteries need to be replaced.

When turning the typewriter on, your screen will prompt:

LOW BATTERY!

To replace the batteries:

- 1 Press **SPACE BAR** or **TAB** to position the printer at the far right of the typewriter
- 2 Open the top cover of the typewriter
- 3 Remove the battery compartment lid

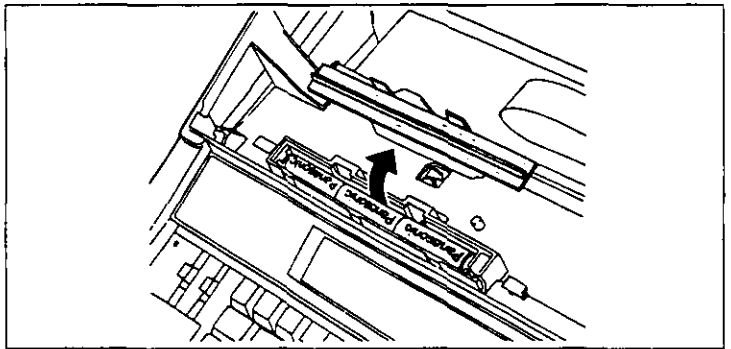

- 4 Push the left edge of the right battery and remove all batteries
- 5 Insert the new batteries as shown in the bottom of the compartment

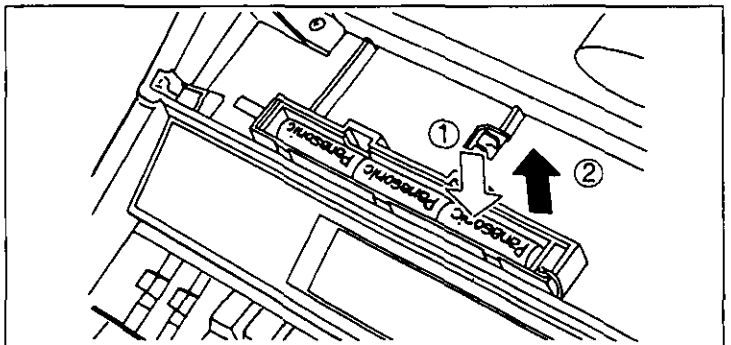

- 6 Replace the lid and close the top cover

# 12-5 PLATEN REMOVAL AND INSTALLATION

## Removing the Platen

If you have to remove the platen to clear a gummed label or clean the platen, please follow the instructions below:

- 1 Turn the power off
- 2 Open the top cover of the typewriter
- 3 Lift the eraser table
- 4 Pull the paper release lever and paper bail release lever toward you

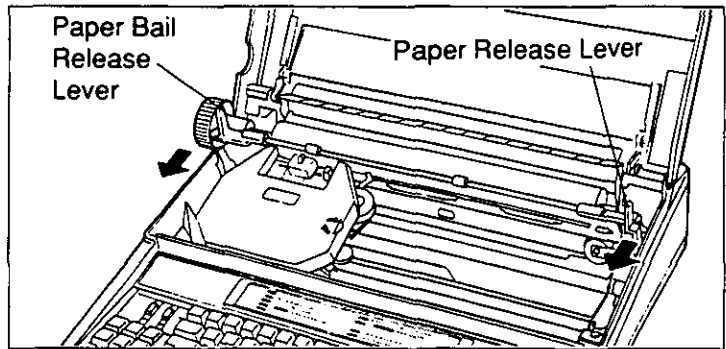

- 5 Pull both levers of the platen holders towards the front of the machine to unlock

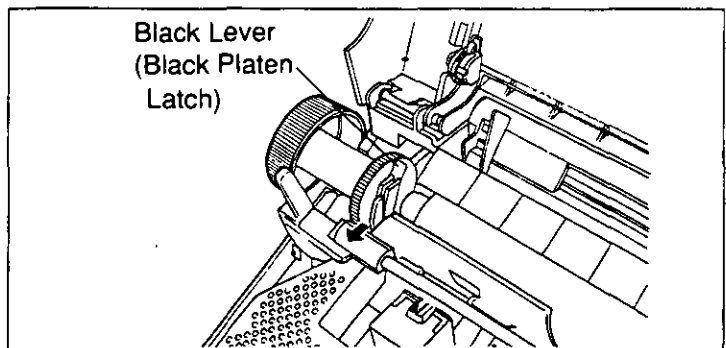

- 6 Lift out the platen



---

## Installing the Platen

- 1** Position the black platen latches (included with Black Levers) inside the side carriage slots
- 2** Push both levers of the platen holders back to secure the platen
- 3** Reset the paper release lever, the paper bail release lever and the eraser table. Then close the top cover

# 12-6 SHIPPING INFORMATION

The carrier stopper keeps the printer stationary during shipping. Remove the stopper before turning the unit on.

When you transport or ship the typewriter, be sure to follow the steps below.

- 1 Position the printer at the far left of the unit
- 2 Install the carrier stopper on the carrier shaft so that the printer does not move

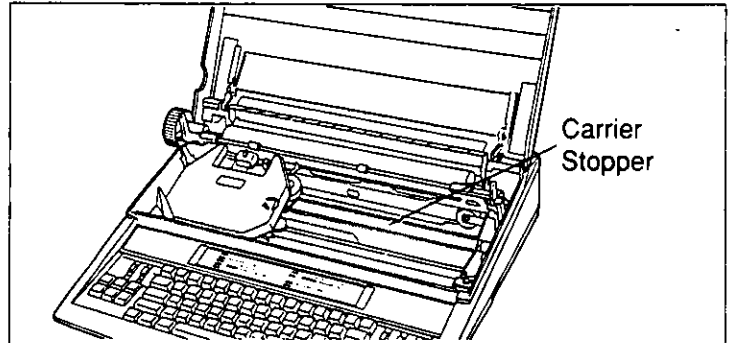

## Disconnecting the Display Unit

If you need to move your system, you should disconnect the display unit.

- 1 Turn the power off

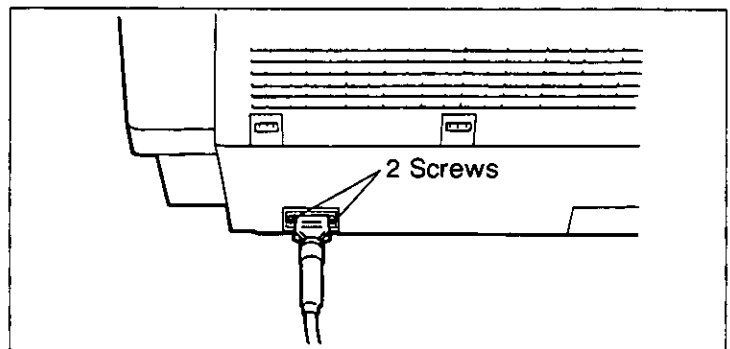

- 2 Unfasten the two screws on the cable connector
- 3 Remove the cable from the connector

To reconnect insert the cable into the connector and tighten the screws.

# 12-7 TROUBLESHOOTING

PROBLEM	REMEDY
1. Character spacing is erratic.	<ul style="list-style-type: none"><li>• Make sure the "Pitch Selector" agrees with the pitch indicated on the daisywheel.</li></ul>
2. Character printout is not clear.	<ul style="list-style-type: none"><li>• Make sure the ribbon is good.</li><li>• Make sure the "Pitch Selector" and "Impact Control Selector" are set correctly.</li></ul>
3. Characters cannot be printed.	<ul style="list-style-type: none"><li>• Make sure the daisywheel is mounted correctly on the printer.</li><li>• Change the ribbon cartridge.</li></ul>
4. Characters cannot be cancelled.	<ul style="list-style-type: none"><li>• Make sure the correction tape matches the type of ribbon cartridge being used.</li><li>• Make sure the correction tape is installed correctly.</li><li>• Change the correction tape.</li></ul>
5. Character printout is scrambled.	<ul style="list-style-type: none"><li>• The printwheel is misaligned. Press <b>CODE + T</b> to reset the typewriter.</li></ul>

# 12-8 SPECIFICATIONS

Print Element:	Daisywheel; 100 char.
Print Speed:	20 characters per second (max. speed)
Print Pitch:	10 char./inch 12 char./inch 15 char./inch Proportional Spacing
Line Spacing:	1, 1½, 2 and 3 lines
Paper Width:	14.2 inches Max.
Writing Line:	11.5 inches Max.
Ribbon Cassette:	Correctable Carbon Ribbon (Black, Blue, Brown) Non Correctable Single Strike Carbon Ribbon (Black) Multi-Strike Ribbon (Black) Fabric Ribbon (Black)
Correcting Tape:	Lift Off Tape Cover Up Tape
Keyboard:	Alpha/Numeric Key; 45 keys Function Key; 28 keys
Correction Memory:	1000 char. Max.
Phrase/Text Memory:	25 K to 57 K
Line Format Memory:	3 Formats+Current
Power Requirements:	Refer to the nameplate located on the rear of the typewriter
Memory Protection:	1 year—3 “AA” size batteries
Storage Environment:	-4°F~140°F (-20°C~60°C) temperature, 10%~90% humidity
Operating Environment:	50°F~104°F (10°C~40°C) temperature, 20%~80% humidity
Dimension:	20¼ <sup>16</sup> (W)×17¾ <sup>8</sup> (D)×6¾ <sup>8</sup> (H) in. (Typewriter) (510×442×174 mm) 9¼ (W)×10½ <sup>8</sup> (D)×9¼ <sup>16</sup> (H) in. (Screen) (235×270×230 mm)
Weight:	Approx. 21 lbs. (9.5 kg) (Typewriter) Approx. 6.6 lbs. (3 kg) (Screen)

Specifications subject to change without notice.

# 12-9 OPTIONS

---

<b>KX-E52</b>	32K Memory Upgrade
<b>KX-EIS1</b>	Serial Interface
<b>KX-EIP1</b>	Parallel Interface
<b>KX-EK7</b>	Arm for CRT

- A** Align words at right margin . . . . . 46  
 Appending . . . . . 110  
   Entire document . . . . . 110  
   Blocks of information . . . . . 111  
 Automatic paper eject . . . . . 26  
 Automatic paper insertion . . . . . 25
- B** **BACKSPACE** key . . . . . 9  
   with **CODE** key . . . . . 56  
 Background Print . . . . . 90  
 Block operation . . . . . 82  
   Copy . . . . . 84  
   Delete . . . . . 83  
   Move . . . . . 83  
   Print . . . . . 84  
   Remove markers . . . . . 85
- C** **CANCEL** (  ) key . . . . . 9  
 Caps lock . . . . . 8  
 Carrier **RETURN** key . . . . . 9  
   Automatic . . . . . 5  
   Manual . . . . . 5  
**CENTER** key . . . . . 8  
 Centering . . . . . 45  
   At right margin . . . . . 46  
   Between margins . . . . . 45  
   Between tabs . . . . . 46  
   Over a point . . . . . 45  
 Changing default settings . . . . . 10  
 Code operations chart . . . . . 222  
 Column layout . . . . . 102, 103  
 Controlled printer movement . . . . . 23  
 Copy control lever . . . . . 3  
 Correcting errors . . . . . 36  
   On the screen . . . . . 41  
   Outside correction memory . . . . . 38  
   Using **NO PRINT** method . . . . . 38  
   Within correction memory . . . . . 37  
 Correction tape . . . . . 227  
 Cover interlock switch . . . . . 3  
 CRT brightness control . . . . . 3  
**CURSOR** keys . . . . . 9  
 Cursor movement . . . . . 56
- D** Daisywheel . . . . . 228  
**DEC TAB** key . . . . . 8  
 Decimal tabs (see tabs) . . . . . 49  
 Default settings . . . . . 10
- Deleting  
   A phrase . . . . . 62  
   A text . . . . . 182  
   Block of text . . . . . 83  
   Entire memory . . . . . 188  
   Entire phrases . . . . . 187  
   Entire texts . . . . . 186  
 Disk drive . . . . . 190  
   Clearing . . . . . 209, 211  
   Formatting . . . . . 194  
   Inserting a disk . . . . . 192  
   Listing . . . . . 204  
   Loading an ASCII file . . . . . 218  
   Loading from Panasonic TW . . . . . 216  
   Mail merge . . . . . 143  
   Printing from disk . . . . . 214  
   Protecting from erasure . . . . . 193  
   Reading text from disk . . . . . 200  
   Renaming texts on disk . . . . . 207  
   Writing text to disk . . . . . 196  
 Dual column typing . . . . . 119, 122  
   Creating . . . . . 121, 123  
   Exiting . . . . . 126  
   Printing . . . . . 126  
   Setting the format . . . . . 119
- E** Embedding symbols . . . . . 22  
 Envelopes . . . . . 68, 139  
**EXPR** key . . . . . 9
- F** Forms layout . . . . . 144  
   Correcting errors . . . . . 151  
   Editing a form . . . . . 152, 153  
   Printing a form . . . . . 149  
   Storing a form . . . . . 147  
**FWD**→ key . . . . . 9  
   with **CODE** key . . . . . 56  
 Function keys . . . . . 8
- G** Global search and replace . . . . . 80
- H** Half space . . . . . 222  
 Halt printing . . . . . 89  
 Headers/Footers . . . . . 93  
**HELP** . . . . . 24  
 Hot zone . . . . . 29  
   Automatic carrier return . . . . . 5  
   Setting & clearing . . . . . 29

Hyphens			
Hyphenation scan	76		
Temporary hyphen	51		
<b>I</b> Impact control selector	6		
Indent ( <b>↑IND</b> )	8, 47		
Block indent	48		
Left indent	47		
<b>INDEX</b> ( <b>↓</b> ) key	9		
Insert Codes	105		
Entering insert codes	105		
Entering variable information	105		
Printing the insert codes	107		
<b>INSERT</b> key	9		
<b>J</b> Justify	5		
Jumping to a page	77		
<b>K</b> Keyboard adjustment lever	2		
Keyboard layout	4		
Character keys	4		
Selector switches	5		
<b>KB I</b>	7		
<b>KB II</b>	7		
<b>L</b> Line framing	112		
Deleting	118		
Line spacing	5		
Lines per vertical inch	11		
Listing			
Phrases	62		
Texts in memory	178		
Texts on disk	204		
<b>LOCK</b> key	8		
<b>M</b> Mail merge	128		
Counting letters	139		
Creating a form letter	129		
Creating a mail list	132		
Envelopes	139		
Merging	133		
Merging from disk	143		
Labels	142		
Qualifiers	136		
Selecting from qualified list	138		
Wildcards	137		
<b>MAIN MENU</b> key	8		
<b>MARGIN RELEASE (M.R.)</b> key	8		
Margins			27
Bypassing	27		
Clearing	28		
Editing	33		
Storing into memory	30		
Recalling from memory	32		
Setting	27		
Memory			
Clearing	186		
Correction memory	36		
Memory left	189		
Phrase memory	58		
Text memory	69		
Micro indexing	26		
Micro space	52		
Mode selector	5		
Modifying a text	72		
Block copy	84		
Block delete	83		
Block move	83		
Direct search	79		
Global search	80		
Inserting a phrase	109		
Multilingual typing	7		
<b>O</b> On/off switch	2		
Overlapped characters	53		
<b>P</b> Page end command	86		
Page numbering	94		
Paper bail release lever	3		
Paper release lever	2		
Permanent backspace	53		
Permanent space	52		
Phrase memory	58		
Clearing	62		
Editing	61		
Linking	67		
Listing	62		
Phrase into text	64		
Printing	61		
Reading from text	65		
Storing	59		
Pitch selector	6		
Platen	230		
Installing	231		
Removing	230		
<b>PRINT</b> key	8		

Printing	86
Background printing	90
Deleting from print queue	96
Justified right margin	5
Ragged right margin	5
From a point	89
Interrupting printing	89
Linking phrases when printing	67
Multiple texts	95
Repetitive printing	92
Text linking	97
With page end	88

<b>Q</b> QUICK ERASE key	9
--------------------------	---

<b>R</b> RELOC key	9
REPEAT key	8
Repetitive printing	92
Reset	189
REVERSE INDEX (↑) key	9
Ribbon cartridge	226
R.MGN key	9
Ruler line	15

<b>S</b> Screen	14
Messages	15, 220
Symbols	16
Searching	78
Global search & replace	80
Selective search & replace	81
Selector switches	5
SHIFT key	8
SPELLCORRECT®	8, 154
Activating	156
Clearing a glossary	174
Correcting errors	158–160
Deactivating	156
Deleting a word	165
Inputing a text into glossary	168
Inserting a word	162
Listing a glossary	172
Outputing a glossary to text	170
Scanning	166
Status line	14
Storing	
Automatic paper feed	25
Page end command	87
Phrase storage	59
Text storage	70
Supplies	226, 234

<b>T</b> TAB key	8
TAB CLR key	9
Tabs	
Centering between	46
Clearing	28
Column layout	102, 103
Decimal	49
Setting tabs	27
TAB SET key	9
Text	69
Creating a text	70
Deleting texts	182, 184
Editing a text	72
Linking	97
Listing	178
Printing	86
Renaming	180, 181

<b>U</b> Underscore	43
Continuous	43
Double	44
Word-by-word	44

<b>X</b> <u>XXX</u> key	8
-------------------------	---









**Panasonic Communications & Systems Company**  
**Division of Matsushita Electric Corporation of America**  
Two Panasonic Way, Secaucus, New Jersey 07094

**Panasonic Sales Company**  
Ave, 65 De Infanteria, KM9.7 Victoria Industrial Park Carolina,  
Puerto Rico 00630

---

**Matsushita Electric Industrial Co., Ltd.**  
Central P. O. Box 288, Osaka 530-91, Japan